

Zebra *XiIII*-Series

User's Guide

Customer Order # 11992L
Manufacturer Part # 11992LB Rev. 2



Proprietary Statement

This manual contains proprietary information of Zebra Technologies Corporation. It is intended solely for the information and use of parties operating and maintaining the equipment described herein. Such proprietary information may not be used, reproduced, or disclosed to any other parties for any other purpose without the expressed written permission of Zebra Technologies Corporation.

Product Improvements

Continuous improvement of products is a policy of Zebra Technologies Corporation. All specifications and signs are subject to change without notice.

FCC Compliance Statement

This equipment has been tested and found to comply with the limits for a Class B digital device, pursuant to Part 15 of the FCC Rules. These limits are designed to provide reasonable protection against harmful interference in a residential installation. This equipment generates, uses, and can radiate radio frequency energy and, if not installed and used in accordance with the instructions, may cause harmful interference to radio communications. However, there is no guarantee that the interference will not occur in a particular installation. If this equipment does cause harmful interference to radio or television reception, which can be determined by turning the equipment off and on, the user is encouraged to try to correct the interference by one or more of the following measures:

- Reorient or relocate the receiving antenna.
- Increase the separation between the equipment and the receiver.
- Connect the equipment into an outlet on a circuit different than that to which the receiver is connected.
- Consult the dealer or an experienced Radio/TV technician for help.

NOTE: This unit was tested with shielded cables on the peripheral devices. Shielded cables must be used with the unit to ensure compliance.

“The user is cautioned that any changes or modifications not expressly approved by Zebra Technologies Corporation could void the user’s authority to operate the equipment.”

Canadian DOC Compliance Statement

This digital apparatus does not exceed the Class A limits for radio noise emissions from digital apparatus as set out in the radio interference regulations of the Canadian Department of Communications.

CE Compliance

If the accompanying printer displays the CE mark, it also meets EMC directive 89/336/EEC, with amendments effective at the time of manufacture.

Liability Disclaimer

Zebra Technologies Corporation takes steps to assure that its published Engineering Specifications and Manuals are correct; however, errors do occur. Zebra Technologies Corporation reserves the right to correct any such errors and disclaims liability resulting therefrom.

No Liability for Consequential Damage

In no event shall Zebra Technologies Corporation or anyone else involved in the creation, production, or delivery of the accompanying product (including hardware and software) be liable for any damages whatsoever (including, without limitation, damages for loss of business profits, business interruption, loss of business information, or other pecuniary loss) arising out of the use of or the results of use or inability to use such product, even if Zebra Technologies Corporation has been advised of the possibility of such damages. Because some states do not allow the exclusion or limitation of liability for consequential or incidental damages, the above limitation may not apply to you.

Copyrights

This copyrighted manual and the label printer described herein are owned by Zebra Technologies Corporation. All rights are reserved. Unauthorized reproduction of this manual or the software in the label printer may result in imprisonment of up to one year and fines of up to \$10,000 (17 U.S.C.506). Copyright violators may be subject to civil liability.

All products and brand names are trademarks of their respective companies. All rights reserved.

© 2001 Zebra Technologies Corporation. All rights reserved.

DECLARATION OF CONFORMITY

I have determined that the Zebra printers identified as the

XiIII[™]-Series
90*XiIII*, 96*XiIII*, 140*XiIII*, 170*XiIII*, and 220*XiIII*

manufactured by:

Zebra Technologies Corporation

333 Corporate Woods Parkway
Vernon Hills, Illinois 60061-3109 U.S.A.

have been shown to comply with the applicable technical standards of the FCC

for Home, Office, Commercial, and Industrial use

if no unauthorized change is made in the equipment,
and if the equipment is properly maintained and operated.

Chris Kueser



Table of Contents

<i>Introduction</i>	1
Hello!	1
Unpacking and Inspection.....	2
Reporting Damage	2
Storage	2
Media and Ribbon Requirements.....	3
Power Cord	3
Printer Anatomy 101	4
<i>Calibrating the Printer</i>	5
Purpose.....	5
Types of Media	6
Non-Continuous Web Media.....	6
Non-Continuous Black Mark Media	7
Continuous Media.....	7
Choosing the Print Mode	8
Loading the Media	9
Positioning the Media Sensors	10
Transmissive Sensor	10
Black Mark Sensor	12
Loading the Ribbon.....	13
Operator Controls.....	14
POWER Switch	14
Front Panel.....	14
Configuring the Printer	15
Configuring the Software or Printer Driver	16
Media and Ribbon Calibration.....	17
Printing a Test Label	19

<i>Establishing Communication</i>	21
System Considerations	21
Interfaces	21
Data Specifications	21
Cabling Requirements	22
<i>Printer Basics</i>	23
Operator Controls	23
POWER Switch	23
Front Panel Display	24
Front Panel Keys	25
Front Panel Lights	26
Roll Media Loading	27
Tear-Off Mode	27
Peel-Off Mode	28
Rewind Mode (for Printers Without the Cutter Option)	30
Cutter Mode	32
Rewind Mode (for Printers With the Cutter Option)	33
Fanfold Media Loading	35
Removing the Label Backing Material	37
Ribbon Loading	38
Ribbon Removal	40
<i>Configuration</i>	41
Entering the Setup Mode	41
Changing Password-Protected Parameters	42
Leaving the Setup Mode	43
Configuration and Calibration Sequence	44
<i>Routine Care and Adjustment</i>	63
Cleaning	63
Cleaning the Exterior	64
Cleaning the Interior	64
Cleaning the Printhead and Platen Roller	64
Cleaning the Sensors	69
Cleaning the Snap Plate	69
Cleaning the Cutter Module	71

Lubrication	71
Fuse Replacement	71
Adjustments	73
Toggle Positioning	73
Printhead Pressure Adjustment	74
Media Sensor Position Adjustment	74
<i>Troubleshooting</i>	75
LED Error Conditions and Warnings	75
Print Quality Problems	78
Wrinkled Ribbon	79
Communications	79
Printer Diagnostics	81
Power-On Self Test	81
Additional Printer Self Tests	81
<i>Specifications</i>	87
Media Handling	87
Options	87
Zebra Programming Language (ZPL II®)	88
Bar Codes	88
General Specifications	89
Printing Specifications	90
Ribbon Specifications	90
Media Specifications	91
Power Line Cord Specifications	92
<i>Appendix</i>	93
Printer Interface Technical Information	93
RS-232/RS-422/RS-485 Serial Data Port	93
Parallel Data Port	97
<i>Index</i>	99



Introduction

Hello!

Thank you for purchasing this high-quality Zebra XiIII™-Series printer, manufactured by the industry leader in quality, service, and value — Zebra Technologies Corporation. For over 25 years, Zebra has provided customers with the highest caliber of products and support.

- This manual provides all of the information you need to operate your printer.
- The *ZPL II® Programming Guide Volume I and Volume II* (part # 45540L) shows you how to create the perfect label format for your application. These books also explain how, through ZBI™, you can extend the power of ZPL II by allowing custom programs to be written that operate within the printer and directly interface with bar code scanners and keyboard display devices. In addition, the books contain information about the enhanced operating system features of your printer. There are three ways to obtain these books: on the accessory CD-ROM (supplied with the printer), on our web site (www.zebra.com), or printed manuals can be ordered from your distributor.
- The *ZebraNet® Networking: PrintServer II™ Installation and User's Guide* (part # 45537L) explains how you can quickly set up your printer on an IP network and experience ZebraLink™, our revolutionary real-time connectivity and control solution for Zebra printers (optional ZebraNet® PrintServer II required).
- There is also a maintenance manual for this printer. This manual (part # 48152L) contains the information you need to maintain your printer.

Unpacking and Inspection

Carefully unpack and inspect the printer for possible damage incurred during shipment.

- Check all exterior surfaces.
- Raise the media access door and inspect the media compartment.

In case shipping is required, save the carton and all packing material. Contact your authorized Zebra reseller for instructions.

Reporting Damage

If you discover shipping damage:

- Immediately notify and file a damage report with the shipping company. *Zebra Technologies Corporation is not responsible for any damage incurred during shipment of the equipment and will not repair this damage under warranty.*
- Keep the carton and all packing material for inspection.
- Notify your authorized Zebra reseller.

Storage

If you are not placing the printer into operation immediately, repackage it using the original packing materials. The printer may be stored under the following conditions:

- Temperature: -4° to $+140^{\circ}$ F (-20° to $+60^{\circ}$ C)
- Relative humidity: 5% to 85% non-condensing

Media and Ribbon Requirements

Since print quality is affected by media and ribbon, printing speeds, and printer operating modes, it is very important to run tests for your applications.

We **STRONGLY RECOMMEND** the use of Zebra Technologies Corporation-brand supplies for continuous high-quality printing. A wide range of paper, polypropylene, polyester, and vinyl stock has been specifically engineered to enhance the printing capabilities of the printer and to ensure against premature printhead wear.

- Continuous roll media, fanfold media, or card stock with optional perforations and registration holes may be used.
- Printhead life may be reduced by the abrasion of exposed paper fibers when using perforated media.
- The ribbon **MUST** be as wide as or wider than the media being used. If the ribbon is narrower than the media, areas of the printhead are unprotected and subject to premature wear. (When printing in direct thermal mode, ribbon is not used and should not be loaded in the printer.)

Power Cord

WARNING! For personnel and equipment safety, always use a three-prong plug with a ground (earth) connection.

NOTE: Depending on how your printer was ordered, a power cord may or may not be included. If one is not included, or if the one included is not suitable for your requirements, refer to “Power Line Cord Specifications” on page 92.

The power cord connector must be plugged into the mating connector on the rear of the printer.

Make sure that the **POWER** on/off switch (located at the back of the printer) is in the off position before connecting the power cable to an electrical outlet.

Printer Anatomy 101

Figure 1 outlines the basic components of your printer. However, depending on the options you have selected, your printer may look slightly different.

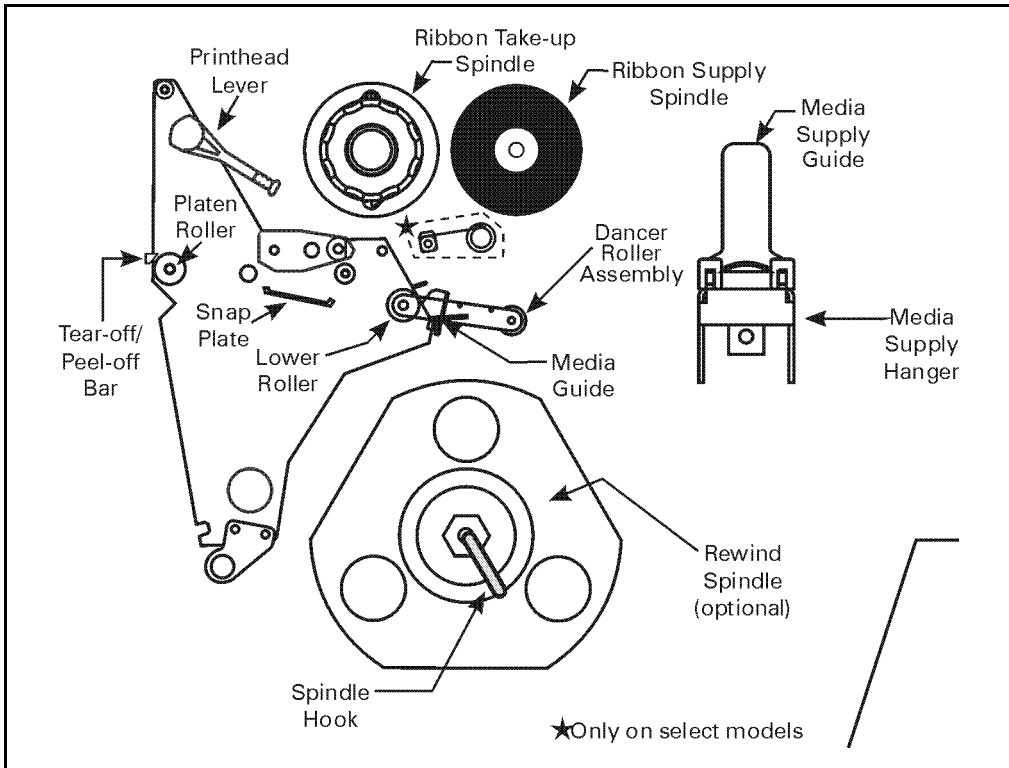

Figure 1

Calibrating the Printer

This chapter of the user's guide is *so* important that we've printed it on a different color paper! That way, it is easy for you to find when you must calibrate (set up) the printer for your particular application.

Purpose

- To calibrate the printer.
- To verify that the printer is properly set up by printing a test label.

NOTE: This procedure *must* be performed when the printer is first installed or when it cannot properly detect the top of the label.

To calibrate the printer, you must perform the following procedures:

- Determine the **type of media** (labels) being used.
- Choose the **print method**.
- Position the **media sensors** (if necessary).
- **Configure the printer and software or driver** based on the label being used.
- Perform a **media and ribbon calibration**.
- Print a **test label**.

Types of Media

Non-Continuous Web Media

Non-continuous web media (refer to Figure 2) refers to individual labels that are separated by a gap, notch, or hole. When you look at the media, you can tell where one label ends and the next one begins.

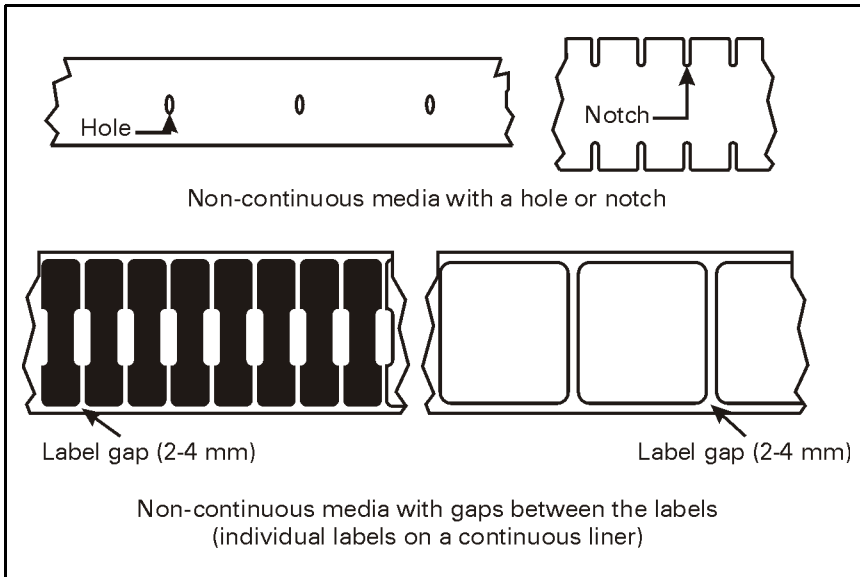

Figure 2

Non-Continuous Black Mark Media

Non-continuous black mark media has black marks printed on the back that indicate the start and end of each label (refer to Figure 3).

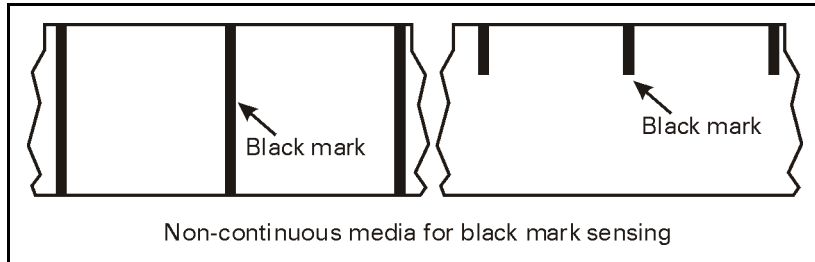

Figure 3

Continuous Media

Continuous media (refer to Figure 4) is one uninterrupted roll of material that allows the image to be printed anywhere on the label.

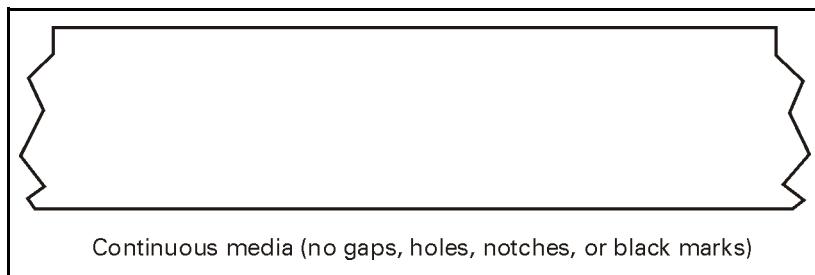

Figure 4

Choosing the Print Mode

- In **Tear-Off** mode, each label (or a strip of labels) can be torn off after it is printed.
- In **Peel-Off** mode, backing material is peeled away from the label as it is printed. After this label is removed from the printer, the next one is printed.
- In **Cutter** mode, the printer automatically cuts the label after a specified number of labels has been printed.
- In **Rewind** mode, the media and backing are rewound onto a core as the labels are printed.

Loading the Media

Figure 5 illustrates one method of media loading. For more detailed instructions, as well as information about how to load the different types of media and the various printing modes, refer to the instructions that begin on page 27.

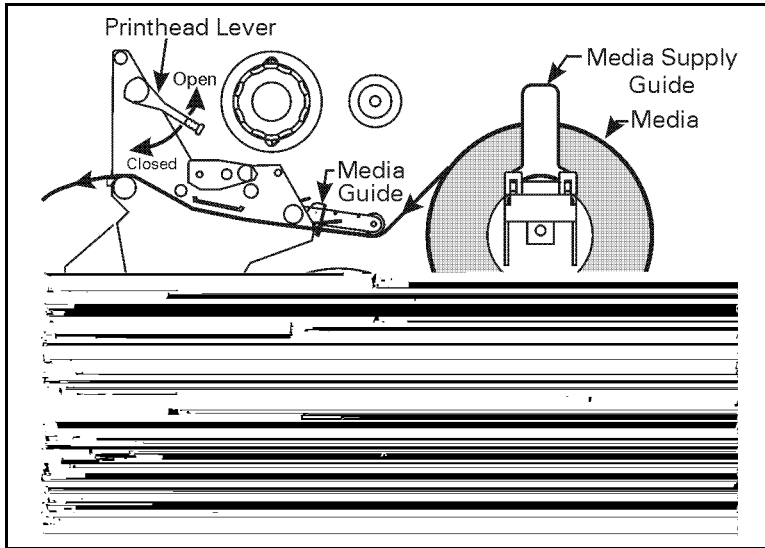

Figure 5

Positioning the Media Sensors

The correct positioning of the media sensors is important — it can make the difference between a perfect label and a call to Technical Support!

Transmissive Sensor

The web or gap sensor, better known as the “transmissive sensor,” detects the gap between labels.

The transmissive sensor actually consists of two sections: a light source (the lower media sensor) and a light sensor (the upper media sensor). The media passes between the two.

The upper media sensor must be positioned:

- Directly over the hole or notch, or
- Anywhere along the width of the media if there is a gap between labels.

NOTE: If you are using continuous media, position the upper media sensor over the media so that the printer can detect an out-of-paper condition.

Adjusting the Upper Media Sensor

Refer to Figure 6. (For clarity, not all printer parts are shown.)

1. Remove the ribbon (if it is installed).
2. Locate the upper media sensor. The upper media sensor “eye” is directly below the adjustment screw head.
3. Slightly loosen the upper media sensor adjustment screw (use a Phillips-head screwdriver).
4. Using the tip of the screwdriver, slide the upper sensor along the slot to the desired position.
5. Secure the upper media sensor adjustment screw.

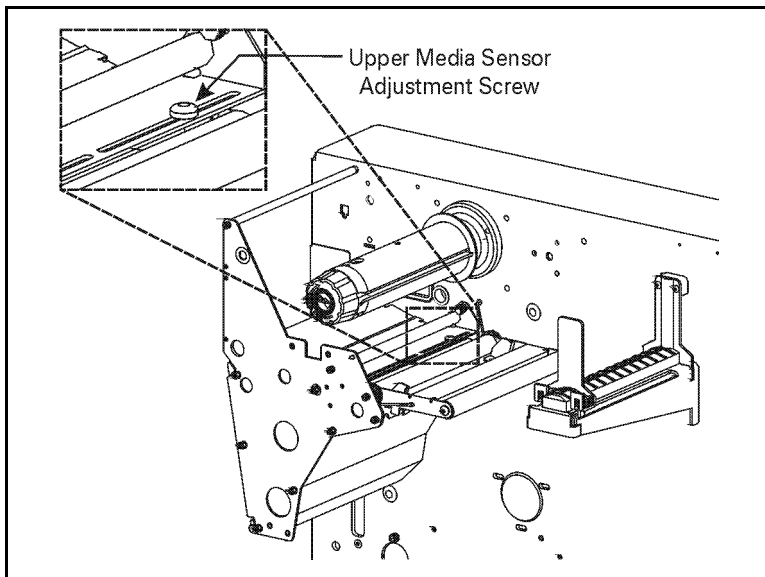

Figure 6

Adjusting the Lower Media Sensor

Position the lower media sensor (refer to Figure 7) by sliding it in its slot until it is positioned under the upper media sensor.

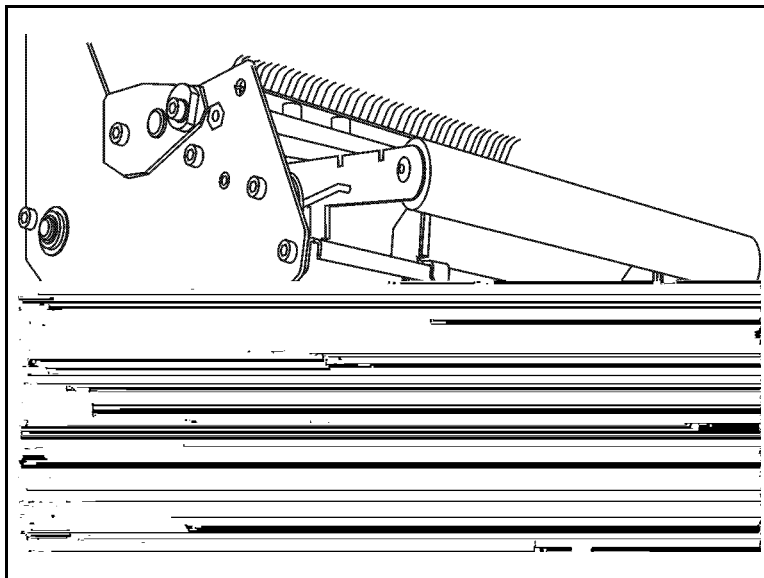

Figure 7

Black Mark Sensor

The black mark sensor is in a fixed position and enabled via the front panel (refer to “Configuring the Printer” on page 15 for details).

Loading the Ribbon

To load the ribbon, refer to Figure 8 (for the 90XiIII, 96XiIII, and 140XiIII) and Figure 9 (for the 170XiIII and 220XiIII). For more detailed information, refer to the instructions that begin on page 38.

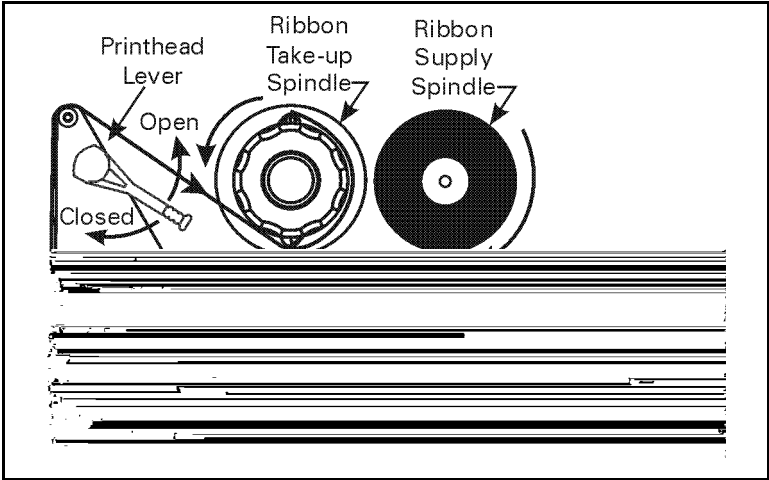

Figure 8

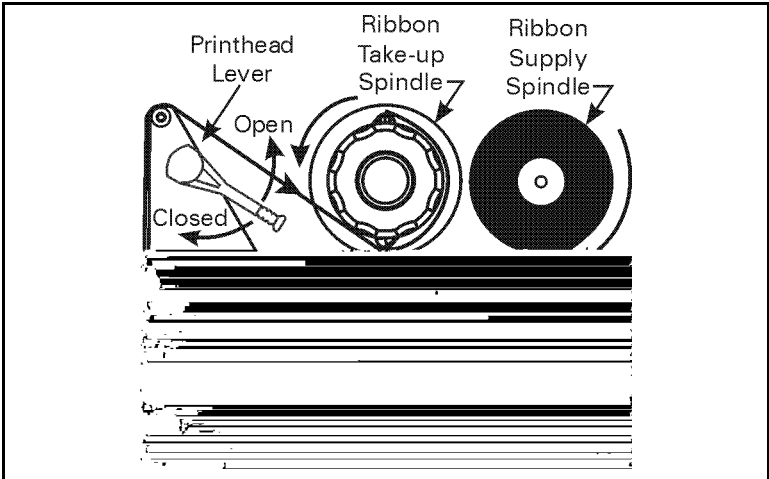

Figure 9

Operator Controls

POWER Switch

The POWER switch is located at the back of the printer above the power cord and fuse. Turn on the printer.

Front Panel

The step-by-step instructions in this section tell you which keys to press and what appears on the liquid crystal display (LCD) during the calibration procedure.

For a more detailed explanation of the front panel keys and lights (as shown in Figure 10), refer to the instructions that begin on page 24.

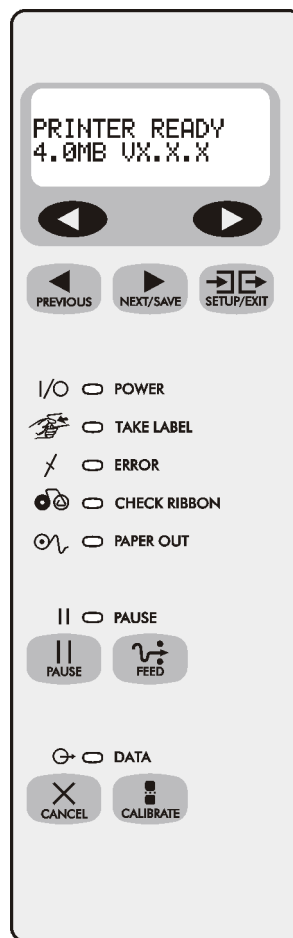

Figure 10

Configuring the Printer

The configuration procedure in the next table contains the information you need to get your printer up and running, *but it is not comprehensive*. Refer to page 41 for more information.

- Enter the configuration mode by pressing the SETUP/EXIT key at the “PRINTER READY” display.

NOTE: You need to press the NEXT/SAVE key more than once to advance to some of the displays.

- To increase the value, answer “yes,” indicate “on,” or move to the next selection, use the RIGHT BLACK OVAL key.
- To decrease the value, answer “no,” indicate “off,” or return to the previous selection, use the LEFT BLACK OVAL key.

NOTE: When changing parameters, an asterisk (*) in the upper left-hand corner of the display indicates that you have changed this setting from the setting that is currently stored in memory.

Media and Ribbon Calibration

NOTE: All steps *must* be performed in the following procedure, even if only one sensor needs to be adjusted.

1. Press the SETUP/EXIT key.
2. Press the NEXT/SAVE key until “MEDIA AND RIBBON CALIBRATE” displays.
3. To start the calibration procedure, press the RIGHT BLACK OVAL key. “LOAD BACKING CANCEL CONTINUE” displays.
4. Open the printhead. Remove approximately 8" (200 mm) of labels from the media roll, enough so that only the backing material is threaded between the media sensors when the media is loaded (refer to Figure 11).

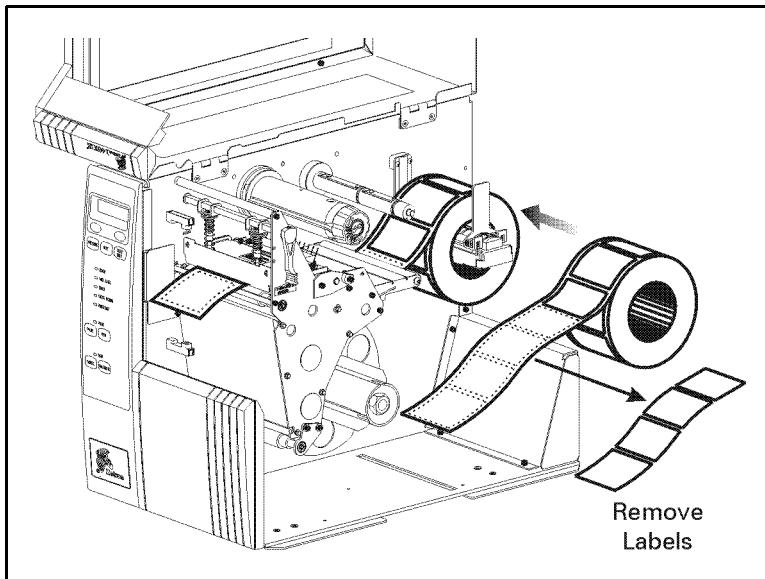

Figure 11

5. Press the RIGHT BLACK OVAL key. The front panel display shows “REMOVE RIBBON CANCEL CONTINUE.”
6. Either remove the ribbon or slide it as far from the printer frame as possible.
7. Close the printhead, trapping the ribbon in this position.
8. Press the RIGHT BLACK OVAL key. The front panel shows “CALIBRATING PLEASE WAIT.”
9. When this part of the calibration process is completed, the display reads “RELOAD ALL CONTINUE.”
10. Open the printhead. Pull the backing material until a label is positioned between the media sensors.
11. Either load the ribbon or return the ribbon to its proper position.
12. Close the printhead. Press the RIGHT BLACK OVAL key to perform the next part of the calibration sequence. “MEDIA AND RIBBON CALIBRATE” displays. The printer is calibrated when the media stops feeding.
13. Press the SETUP/EXIT key to leave the programming mode. Choose “permanent” when SAVE CHANGES displays.

Printing a Test Label

To print a test label:

1. Turn off the printer.
2. Press and hold the CANCEL key while turning on the printer.

A configuration label prints showing the printer's currently stored parameters (similar to the one shown in Figure 12).

PRINTER CONFIGURATION	
Zebra Technologies ZTC 140XiIII-200dpi	
+10.....	DARKNESS
+000.....	TEAR OFF
TEAR OFF.....	PRINT MODE
NON-CONTINUOUS.....	MEDIA TYPE
WEB.....	SENSOR TYPE
THERMAL-TRANS.....	PRINT METHOD
128 0/8 MM.....	PRINT WIDTH
1722.....	LABEL LENGTH
39.0IN 988MM.....	MAXIMUM LENGTH
PARALLEL.....	PARALLEL COMM.
RS232.....	SERIAL COMM.
19200.....	BAUD
8 BITS.....	DATA BITS
NONE.....	PARITY
2 STOP BITS.....	STOP BITS
XON/XOFF.....	HOST HANDSHAKE
NONE.....	PROTOCOL
000.....	NETWORK ID
NORMAL MODE.....	COMMUNICATIONS
< > 7EH.....	CONTROL PREFIX
<^> 5EH.....	FORMAT PREFIX
<,> 2CH.....	DELIMITER CHAR
ZPL II.....	ZPL MODE
FEED.....	MEDIA POWER UP
FEED.....	HEAD CLOSE
DEFAULT.....	BACKFEED
+010.....	LABEL TOP
+0000.....	LEFT POSITION
0000.....	HEAD TEST COUNT
0500.....	HEAD RESISTOR
OFF.....	VERIFIER PORT
OFF.....	APPLICATOR PORT
057.....	WEB S.
075.....	MEDIA S.
064.....	RIBBON S.
092.....	MARK S.
092.....	MARK MED S.
013.....	MEDIA LED
046.....	RIBBON LED
000.....	MARK LED
+10.....	LCD ADJUST
DPSWFXM.....	MODES ENABLED
.....	MODES DISABLED
1024 8/MM FULL.....	RESOLUTION
.....	SOCKET ID
V33.10.0 <-.....	FIRMWARE
.....	HARDWARE ID
CUSTOMIZED.....	CONFIGURATION
12288.....	R: RAM
4096.....	B: MEMORY CARD
2048.....	E: ONBOARD FLASH
NONE.....	FORMAT CONVERT
007 POWER SUPPLY.....	J12 INTERFACE
*** CUTTER.....	J11 INTERFACE
005 DISPLAY.....	J10 INTERFACE
*** NONE.....	J9 INTERFACE
*** NONE.....	J8 INTERFACE
*** NONE.....	J7 INTERFACE
.....	TWINAX/COAX ID
NONE.....	ZEBRA NET II

FIRMWARE IN THIS PRINTER IS COPYRIGHTED

Figure 12

If you encounter any problems while you are configuring or calibrating the printer or printing a test label, refer to *Troubleshooting*, which starts on page 75. Otherwise, refer to *Establishing Communication* on page 21 to set up the communication parameters.



Establishing Communication

System Considerations

Interfaces

The method of interfacing this printer to a data source depends on the communication options installed in the printer. The standard interfaces are an RS-232/RS-422/RS-485 serial data port and a bi-directional parallel port. The optional ZebraNet[®] PrintServer II enables printers to be connected to 10Base-T Ethernet networks. In addition, the IBM[®] Twinax or IBM Coax option is available for those applications that require them.

Data Specifications

When communicating via an asynchronous serial data port (refer to Figure 13), the baud rate, number of data and stop bits, parity, and handshaking are user selectable. Parity only applies to data transmitted by the printer since the parity of received data is ignored.

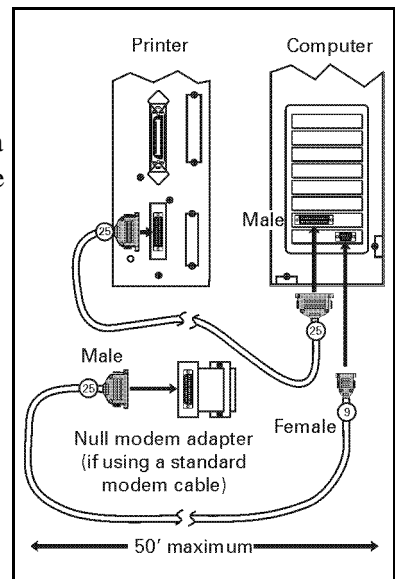

Figure 13

When communicating via the parallel port (refer to Figure 14), the previously mentioned parameters are not considered. Refer to page 51 to configure the communication parameters for the printer. The values selected must be the same as those used by the host equipment connected to the printer.

For serial and parallel pinout and technical information, refer to “Appendix” on page 93.

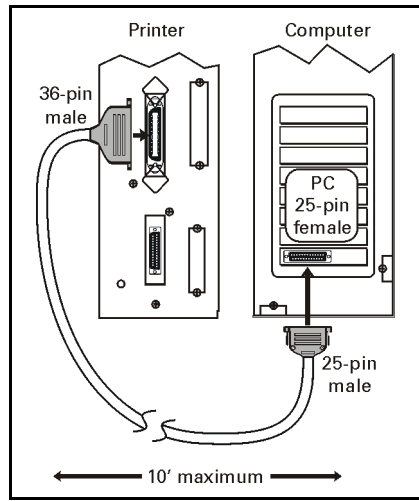

Figure 14

Cabling Requirements

Data cables must be fully shielded and fitted with metal or metalized connector shells. Shielded cables and connectors are required to prevent radiation and reception of electrical noise.

To minimize electrical noise pickup in the cable:

- Keep data cables as short as possible.
- Do not bundle the data cables tightly with the power cords.
- Do not tie the data cables to power wire conduits.

NOTE: Zebra printers comply with FCC “Rules and Regulations”, Part 15, Subpart J, for Class A Equipment, using fully shielded 6' data cables. Use of longer cables or unshielded cables may increase radiated emissions above the Class A limits.

RS-422 and RS-485 applications should use twisted shielded pairs as recommended in the Appendix of the TIA/EIA.-485 Specification.

Printer Basics

Operator Controls

This section discusses the functions of the various controls and indicators on the printer. Become familiar with each of these functions before operating the printer.

POWER Switch

This switch is located at the back of the printer above the power cord and fuse. The POWER switch should be turned off before connecting or disconnecting any cables.

External influences, such as lightning storms or noise on the power or data cables, may cause erratic printer behavior. Turning the printer's power off and back on may re-establish proper printer operation.

Front Panel Display

The front panel display (as shown in Figure 15) communicates operational status and programming modes and parameters.

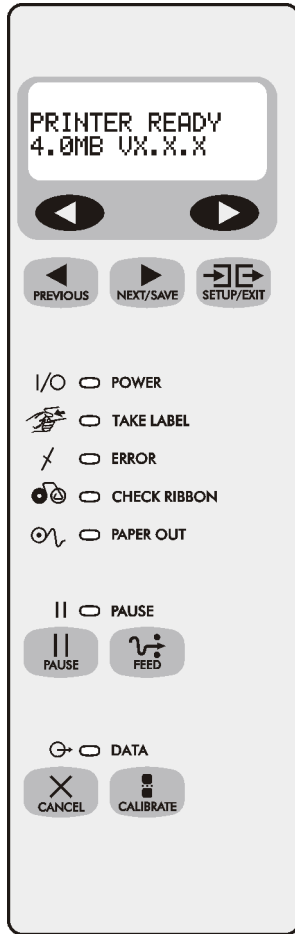

















Figure 15

Front Panel Keys

Key	Function
 PAUSE	<p>Starts and stops the printing process.</p> <ul style="list-style-type: none"> • If the printer is not printing: no printing can occur. • If the printer is printing: printing stops once the current label is complete. <p>Press to remove error messages from the display. NOTE: Pause mode can also be activated via ZPL II (~PP, ^PP).</p>
 FEED	<p>Forces the printer to feed one blank label each time the key is pressed.</p> <ul style="list-style-type: none"> • Printer not printing: one blank label immediately feeds. • Printing: one blank label feeds after the current batch of labels is complete. <p>NOTE: Equivalent to the Slew to Home Position (~PH, ^PH) ZPL II instruction.</p>
 CANCEL	<p>When in the pause mode, this key cancels print jobs.</p> <ul style="list-style-type: none"> • Print job in queue: press once for each print job to be deleted. • Press and hold for several seconds to cancel all print jobs in the printer's memory. The DATA light turns off.
 CALIBRATE	<p>When in the pause mode, this key calibrates the printer for:</p> <ul style="list-style-type: none"> • Media length. • Media type (continuous or non-continuous). • Print mode (direct thermal or thermal transfer). • Sensor values.
<p>NOTE: The keys below are used only when configuring the printer. Specific uses of these keys are explained in "Configuration", beginning on page 41.</p>	
 PREVIOUS	<ul style="list-style-type: none"> • Scrolls back to the previous parameter. • Press <i>and hold</i> to quickly go backward through parameter sets.
 NEXT/SAVE	<ul style="list-style-type: none"> • Scrolls forward to the next parameter. (Saves any changes you've made in the configuration and calibration sequence.) • Press <i>and hold</i> to quickly advance through parameter sets.
 SETUP/EXIT	<p>Enters and exits the configuration mode.</p>
 	<p>These keys change the parameter values. They are used in different ways depending on the parameter displayed. Common uses are: to increase/decrease a value; answer "yes" or "no"; indicate "on" or "off"; scroll through several choices; input the password; or set up the printer for a firmware download.</p>

Front Panel Lights

NOTE: If two operating conditions occur simultaneously (for example, one that causes a light to be on constantly and one that causes the same light to flash), the light flashes.

Light	Status	Indication
POWER 	Off	The printer is off or power is not applied.
	On	The printer is on.
TAKE LABEL 	Off	Normal operation.
	Flashing	(Peel-off mode only.) The label is available. Printing is paused until the label is removed.
ERROR 	Off	Normal operation — no printer errors.
	Flashing	A printer error exists. Check the display screen for more information.
CHECK RIBBON 	Off	Normal operation — ribbon (if used) is properly loaded.
	On	Printing is paused, the front panel displays a warning message, and the PAUSE light is on. <ul style="list-style-type: none"> • If the printer is in direct thermal mode: Ribbon is loaded. • If the printer is in thermal transfer mode: No ribbon is loaded.
PAPER OUT 	Off	Normal operation — media is properly loaded.
	On	No media is under the media sensor. Printing is paused, the display shows an error message, and the PAUSE light is on.
PAUSE 	Off	Normal operation.
	On	The printer has stopped all printing operations. Either the PAUSE key was pressed, a pause command was included in the label format, the on-line verifier detected an error, or a printer error was detected. Refer to the display screen for more information.
DATA 	Off	Normal operation. No data being received or processed.
	On	Data processing or printing is taking place. No data is being received.
	Flashing	The printer is receiving data from <i>or</i> sending status information to the host computer. Flashing slows when the printer cannot accept more data, but returns to normal once data is again being received.

Roll Media Loading

NOTE: A calibration must be performed when media and ribbon (if used) are first installed in the printer, or when a different type of media or ribbon is being used.

Tear-Off Mode

Refer to Figure 16.

1. Open the printhead.
2. Slide the media guide and media supply guide as far from the printer frame as possible. Flip down the media supply guide.
3. Load media as shown.
4. Flip up the media supply guide. Slide in the media guide and media supply guide so they just touch, but don't restrict, the edge of the roll.
5. Close the printhead.

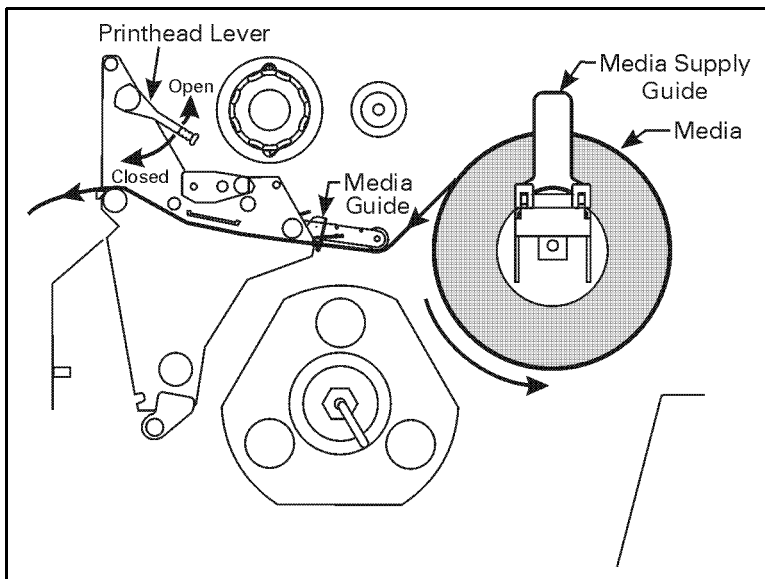

Figure 16

Peel-Off Mode

Refer to Figure 17.

1. Remove the rewind plate from the front of the printer (if installed). Store it on the two mounting screws on the inside of the front panel.
2. Open the printhead.
3. Slide the media guide and media supply guide as far from the printer frame as possible. Flip down the media supply guide.
4. Load media as shown.
5. When loading media, allow approximately 36" (915 mm) of media to extend past the tear-off/peel-off bar. Remove all labels from this portion to create a leader.
6. Remove the hook from the rewind spindle. If you are using a core, slide it onto the rewind spindle until it is flush against the guide plate.
7. Wind the label backing around either the 3" (76 mm) core *or* the rewind spindle and reinstall the hook.
8. Flip up the media supply guide. Slide in the media guide and media supply guide so they just touch, but don't restrict, the edge of the roll.

Before closing the printhead, make sure:

- The media is positioned against the inside guides.
 - The media is taut and parallel with itself and the pathway when wound onto the rewind spindle/core.
9. Close the printhead.
 10. To discard the label backing from the rewind spindle, refer to "Removing the Label Backing Material" on page 37.

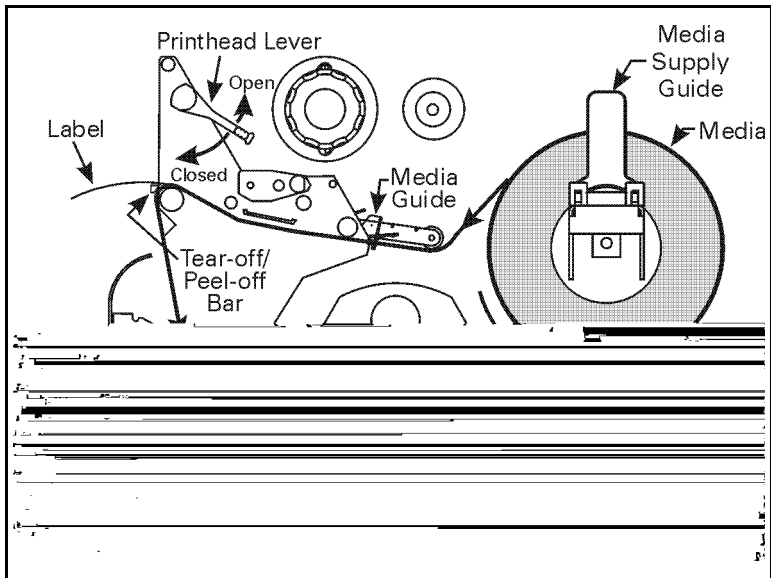

Figure 17

Rewind Mode (for Printers Without the Cutter Option)

NOTE: Rewind option required.

Refer to Figure 18.

1. Remove the rewind plate from its storage location in front of the print mechanism inside the media compartment.
2. Invert the rewind plate so that the lip on the attached hook plate points down.
3. Insert the hook plate lip a short distance ($\frac{1}{2}$ "/13 mm) into the lower opening in the side plate.
4. Align the upper end of the rewind plate with the corresponding opening in the side plate. Slide in the rewind plate so that it stops against the printer's main frame.
5. Open the printhead.
6. Slide the media guide and media supply guide as far from the printer frame as possible. Flip down the media supply guide.
7. Load media as shown.
8. When loading media, allow approximately 36" (915 mm) of media to extend past the printhead. Remove all labels from this portion to create a leader.
9. Remove the hook from the rewind spindle. If you are using a core, slide it onto the rewind spindle until it is flush against the guide plate.
10. Wind the label backing around either the 3" (76 mm) core *or* the rewind spindle and reinstall the hook.
11. Flip up the media supply guide. Slide in the media guide and media supply guide so they just touch, but don't restrict, the edge of the roll.

Before closing the printhead, make sure:

- The media is positioned against the inside guides.
- The media is taut and parallel with itself and the pathway when wound onto the rewind spindle/core.

12. Close the printhead.

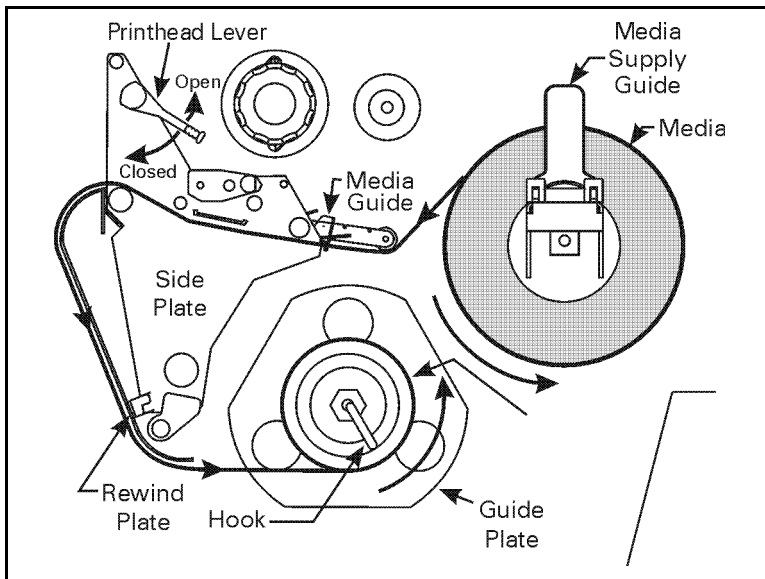

Figure 18

Cutter Mode

NOTE: Cutter option required.

Refer to Figure 19.

1. Open the printhead.
2. Slide the media guide and media supply guide as far from the printer frame as possible. Flip down the media supply guide.
3. Load media as shown.
4. Flip up the media supply guide. Slide in the media guide and media supply guide so they just touch, but don't restrict, the edge of the roll.
5. Close the printhead.
6. The printer automatically feeds out and cuts one label when the printer is turned on.

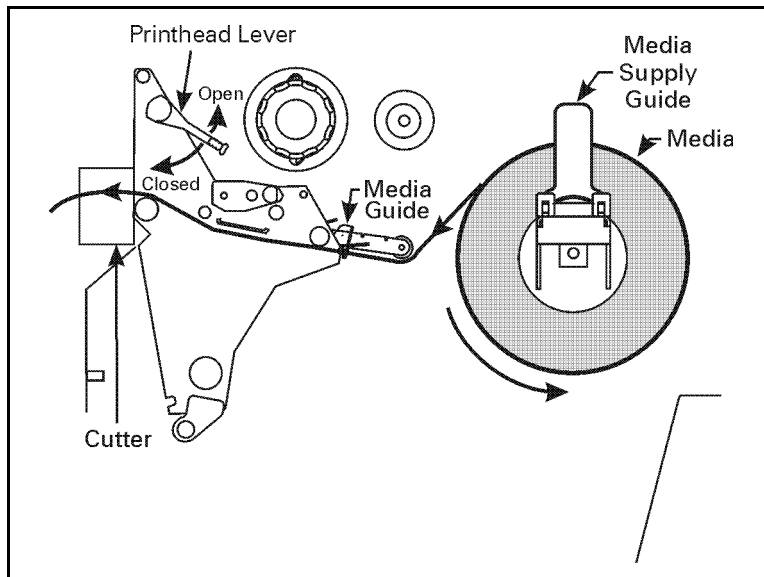

Figure 19

Rewind Mode (for Printers With the Cutter Option)

NOTE: Cutter and rewind options required.

Refer to Figure 20.

1. Remove the rewind plate from its storage location in front of the print mechanism inside the media compartment.
2. Invert the rewind plate so that the lip on the attached hook plate points down.
3. Insert the hook plate lip a short distance ($\frac{1}{2}$ "/13 mm) into the lower opening in the side plate. Slide in the rewind plate so that it stops against the printer's main frame.
4. Insert the two small tabs on the rewind plate into the corresponding slots in the cutter support bracket. (The rewind plate should spring into the proper position.)
5. Open the printhead.
6. Slide the media guide and media supply guide as far from the printer frame as possible. Flip down the media supply guide.
7. Load media as shown.
8. When loading media, allow approximately 36" (915 mm) of media to extend past the printhead. Remove all labels from this portion to create a leader.
9. Remove the hook from the rewind spindle. If you are using a core, slide it onto the rewind spindle until it is flush against the guide plate.
10. Wind the label backing around either the 3" (76 mm) core or the rewind spindle and reinstall the hook.
11. Flip up the media supply guide. Slide in the media guide and media supply guide so they just touch, but not restrict, the edge of the roll.

Before closing the printhead, make sure:

- The media is positioned against the inside guides.
- The media is taut and parallel with itself and the pathway when wound onto the rewind spindle/core.

12. Close the printhead.

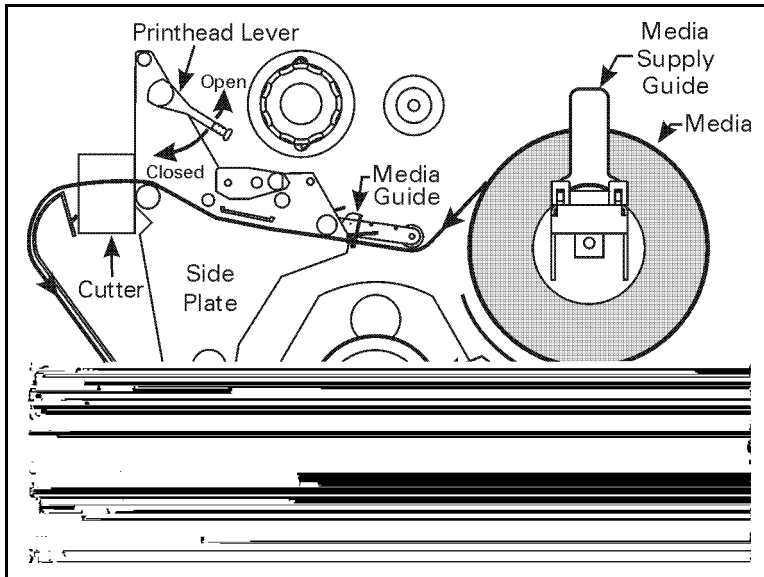

Figure 20

Fanfold Media Loading

NOTE: A calibration must be performed when media and ribbon (if used) are first installed in the printer, or when a different type of media or ribbon is being used.

Fanfold media feeds through either the bottom or rear access slot from outside the printer.

Refer to Figure 21 and Figure 22.

1. Open the printhead.
2. Slide the media guide as far from the printer frame as possible.
3. Load media as shown. If in cutter mode, route media through the cutter.
4. Slide in the media guide so it just touches, but doesn't restrict, the edge of the roll.
5. Close the printhead.

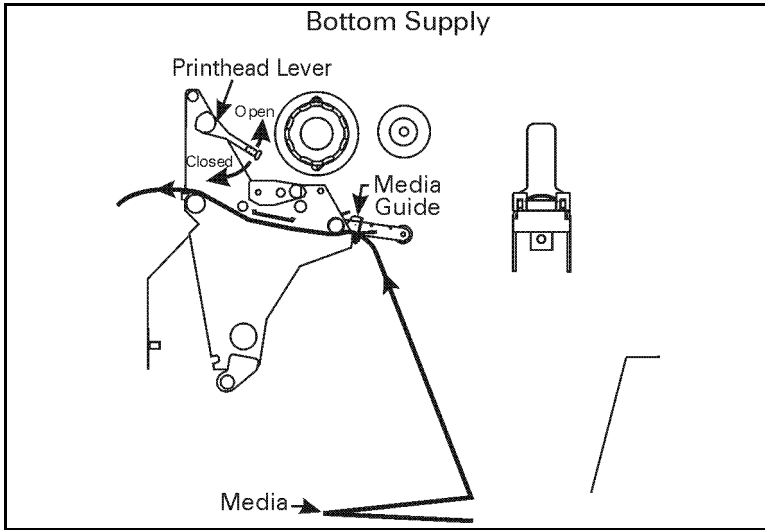

Figure 21

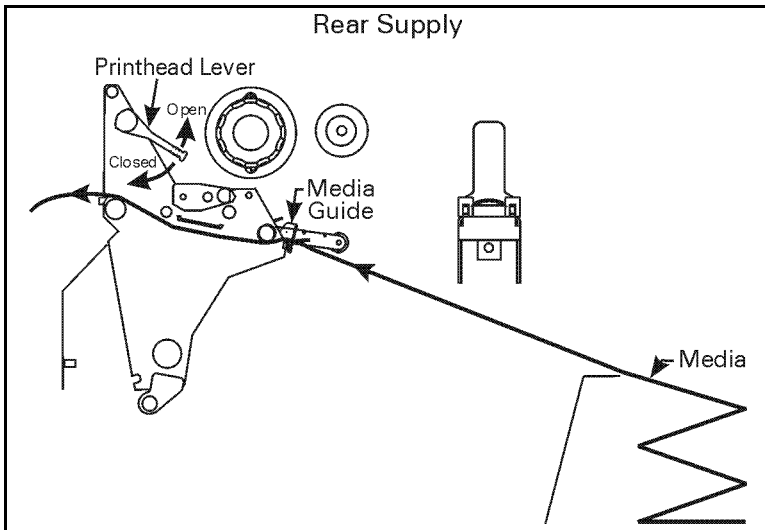

Figure 22

Removing the Label Backing Material

Since the rewind spindle holds the backing from a standard-size media roll, we recommend that you perform this procedure whenever you change the media.

To remove the backing material from the rewind spindle, follow these steps (you don't need to turn off the printer for this procedure).

1. Unwind approximately 36" (915 mm) of backing from the rewind spindle. Cut it off at the spindle.
2. Pull out the hook. Slide the backing material off of the rewind spindle and discard.
3. Wind the media around the rewind spindle once or twice and reinstall the hook. Continue winding to remove any slack in the media.

Ribbon Loading

To load ribbon, refer to Figure 23 (for the 90XiIII, 96XiIII, and 140XiIII) and Figure 24 (for the 170XiIII and 220XiIII) and follow the procedure below.

NOTE: Use ribbon that is at least as wide as the media. The smooth backing of the ribbon protects the printhead from wear and premature failure due to excessive abrasion. *(For direct thermal print mode, ribbon is not used and should not be loaded in the printer.)*

1. Align the segments of the ribbon supply spindle.
2. Place the ribbon roll on the ribbon supply spindle.

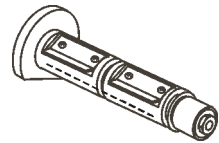

NOTE: Make sure that the core is pushed up against the stop on the ribbon supply spindle and that the ribbon is aligned squarely with its core. If this is not done, the ribbon may not cover the printhead entirely on the inside, exposing print elements to potentially damaging contact with the media.

3. Open the printhead.
4. (Optional) To make ribbon loading and unloading easier, make a leader for your ribbon roll.
5. Tear off a strip of media (labels and backing) about 6"-12" (150 mm-300 mm) long from the roll. Peel off a label from this strip. Apply half of this label to the end of the strip and the other half to the end of the ribbon. This acts as a ribbon leader.
6. Thread the ribbon (with leader, if used) as shown without creasing or wrinkling it.

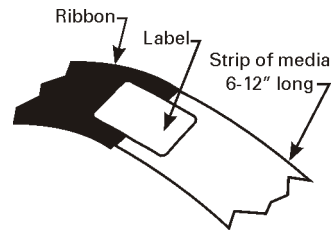

7. Before wrapping the ribbon around the take-up spindle, ensure that the arrow on the knob aligns with the indented notch (see Figure 25 inset).
8. Place the ribbon (with leader, if used) around the ribbon take-up spindle and wind counterclockwise for several turns.
9. Close the printhead.

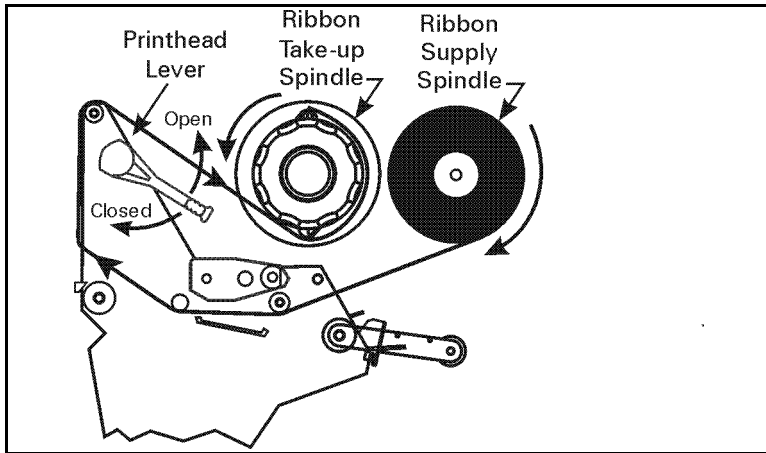

Figure 23

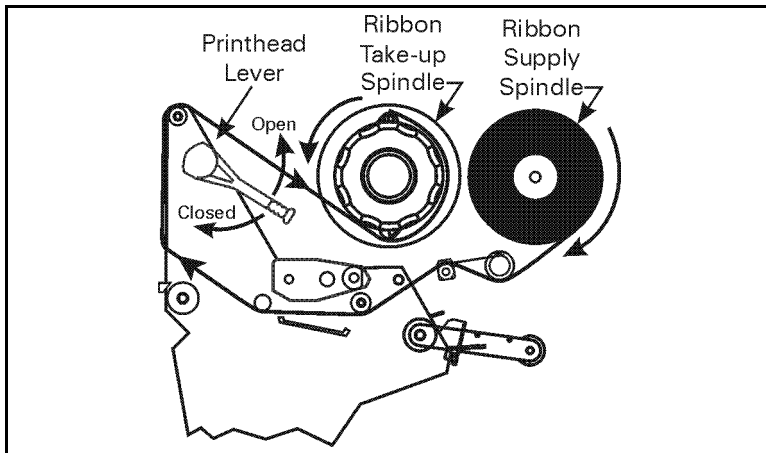

Figure 24

Ribbon Removal

Refer to Figure 25.

1. Break the ribbon as close to the ribbon take-up spindle as possible.
2. While holding the ribbon take-up spindle, turn the knob (1) clockwise until it stops. This causes the ribbon release bars to pivot down (2), easing the spindle's "grip" on the wound ribbon.
3. Slide the ribbon off of the ribbon take-up spindle. Once the spent ribbon has been removed, ensure that the arrow on the knob aligns with the indented notch in the ribbon take-up spindle (see Figure 25 inset).
4. Remove the core from the ribbon supply spindle.
5. Follow the ribbon loading procedure on page 38 to load the new ribbon.

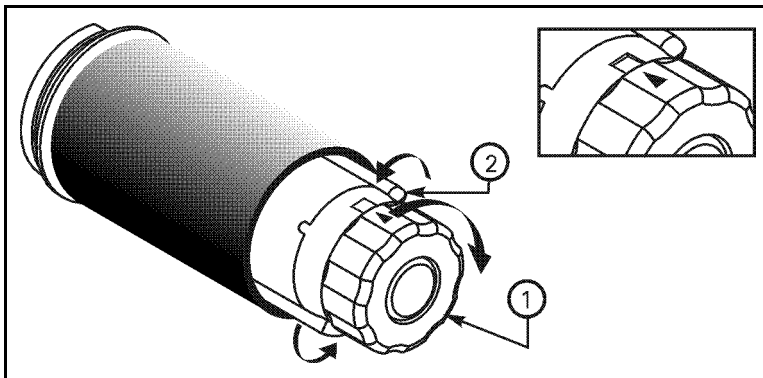

Figure 25

Configuration

After you have installed the media and ribbon and the Power-On Self Test (POST) is complete, the front panel display shows “PRINTER READY.” (If the printer fails its POST, refer to page 81.) You may now set printer parameters for your application using the front panel display and the five keys directly below it.

NOTE: Printers that are operating on an IP network can be quickly configured via ZebraLink™ WebView (optional ZebraNet® PrintServer II required). For information, refer to *ZebraNet Networking: PrintServer II Installation and User's Guide*.

If it becomes necessary to restore the initial printer defaults, see “FEED Key and PAUSE Key Self Test” on page 85.

NOTE: Unless otherwise noted, all parameters are listed in the order they are displayed, starting with “DARKNESS.”

Entering the Setup Mode

To enter the programming mode, press the SETUP/EXIT key. Press either the NEXT/SAVE key or PREVIOUS key to scroll to the parameter you wish to set.

NOTE: You may also press *and hold* the NEXT/SAVE and PREVIOUS keys to quickly advance through the configuration parameters.

Parameters in this section are shown in the order displayed when pressing the NEXT/SAVE key. Throughout this process, press the NEXT/SAVE key to continue to the next parameter, or press the PREVIOUS key to return to the previous parameter in the cycle.

An asterisk (*) in the upper left-hand corner of the display indicates that the value displayed is different than the currently stored value.

Changing Password-Protected Parameters

Certain parameters are password-protected by factory default.

CAUTION: Do not change password-protected parameters unless you are sure you know what you are doing! If the parameters are set incorrectly, they could cause the printer to function in an unpredictable way.

The first attempt to change one of these parameters (pressing one of the BLACK OVAL keys) requires you to enter a four-digit password. This is done via the “ENTER PASSWORD” display. The LEFT BLACK OVAL key changes the selected digit position; the RIGHT BLACK OVAL key increases the selected digit value. After entering the password, press the NEXT/SAVE key. The parameter you wish to change is displayed. If the password was entered correctly, you can now change the value.

The default password value is 1234. The password can be changed using the ^KP (Define Password) ZPL II instruction or through ZebraLink™ WebView (optional ZebraNet® PrintServer II required).

NOTE: Once the password has been entered correctly, it does not have to be entered again unless you leave and re-enter the programming mode using the SETUP/EXIT key, or if you power the printer down and then re-enter the programming mode.

You can disable the password protection feature so that it no longer prompts you for a password by setting the password to ØØØØ via the ^KPØ ZPL/ZPL II command. To re-enable the password-protection feature, send the ZPL/ZPL II command ^KPx, where “x” can be any number, one to four digits in length, except Ø.

Leaving the Setup Mode



You can leave the program mode at any time by pressing the SETUP/EXIT key. The “SAVE CHANGES” display appears. There are five choices, as described below. Pressing the LEFT or RIGHT BLACK OVAL key displays other choices and pressing the NEXT/SAVE key selects the displayed choice.



- **PERMANENT** — Permanently saves the changes. Values are stored in the printer even when power is turned off.
- **TEMPORARY** — Saves the changes until you change them again or until power is turned off.
- **CANCEL** — Cancels all changes from the time you pressed the SETUP/EXIT key except the darkness and tear-off settings (if they were changed).
- **LOAD DEFAULTS** — Loads factory defaults. The factory defaults are shown on the following pages.



NOTE: Loading factory defaults requires printer calibration.







- **LOAD LAST SAVE** — Loads values from the last permanent save.



Configuration and Calibration Sequence

Press	Display Shows	Action/Explanation
—	PRINTER READY	Normal printer operation.
Setting Print Parameters		
	DARKNESS	<p>Adjusting Print Darkness: Press the RIGHT BLACK OVAL key to increase darkness. Press the LEFT BLACK OVAL key to decrease darkness.</p> <p>Default: +10</p> <p>Range: 0 to +30</p> <p>Darkness settings are dependent upon a variety of factors including ribbon type, media, and the condition of the printhead. You may adjust the darkness for consistent high-quality printing. If printing is too light, or if there are voids in printed areas, you should increase the darkness. If printing is too dark, or if there is spreading or bleeding of printed areas, you should decrease the darkness.</p> <p>The FEED Key Self Test on page 84 can also be used to determine the best darkness setting. Since the darkness setting takes effect immediately, you can see the results on labels that are currently printing.</p> <p>CAUTION: Set the darkness to the lowest setting that provides good print quality. Darkness set too high may cause ink smearing and/or it may burn through the ribbon.</p> <p>Darkness settings also may be changed by the driver or software settings.</p>
	TEAR OFF	<p>Adjusting the Tear-Off Position: Press the RIGHT BLACK OVAL key to increase the value, press the LEFT BLACK OVAL key to decrease the value. Each press of the key adjusts the tear-off position by four dot rows.</p> <p>Default: +0</p> <p>Range: -120 to +120</p> <p>This parameter establishes the position of the media over the tear-off/peel-off bar after printing.</p>
	PRINT MODE	<p>Selecting Print Mode: Press the RIGHT or LEFT BLACK OVAL key to display other choices.</p> <p>Default: Tear-off</p> <p>Selections: Tear-off, peel-off, cutter, rewind, applicator</p> <p>Print mode settings tell the printer the method of media delivery that you wish to use. Be sure to select a print mode that your hardware configuration supports since some selections displayed are for optional printer features.</p>

Press	Display Shows	Action/Explanation
	MEDIA TYPE	<p>Setting Media Type: Press the RIGHT or LEFT BLACK OVAL key to display other choices. Default: Continuous Selections: Continuous, non-continuous This parameter tells the printer the type of media you are using. Selecting continuous media requires that you include a label length instruction in your label format (^Lxxxx if you are using ZPL or ZPL II). When non-continuous media is selected, the printer feeds media to calculate label length (the distance between two recognized registration points of the inter-label gap, webbing, or alignment notch or hole).</p>
	SENSOR TYPE	<p>Setting the Sensor Type: Press the RIGHT or LEFT BLACK OVAL key to display other choices. Default: Web Selections: Web, mark This parameter tells the printer whether you are using media with a web (gap/space between labels, notch, or hole) to indicate the separations between labels or if you are using media with a black mark printed on the back. If your media does not have black marks for registration on the back, leave your printer at the default (web).</p>
	PRINT METHOD	<p>Selecting Print Method: Press the RIGHT BLACK OVAL key for the next value; press the LEFT BLACK OVAL key for the previous value. Default: Thermal transfer Selections: Thermal transfer, direct thermal The print method parameter tells the printer the method of printing you wish to use: direct thermal (no ribbon) or thermal transfer (using thermal transfer media and ribbon). NOTE: Selecting direct thermal when using thermal transfer media and ribbon creates a warning condition, but printing continues.</p>

Press	Display Shows	Action/Explanation
	PRINT WIDTH	<p>Setting Print Width: Press the RIGHT BLACK OVAL key to increase the value, press the LEFT BLACK OVAL key to decrease the value. To change the unit of measurement, press the LEFT BLACK OVAL key until the unit of measurement is active, then press the RIGHT BLACK OVAL key to toggle to a different unit of measure (mm, inches, or dots).</p> <p>Default; Range: The default and range of acceptable values vary depending on what printer you have. Refer to “Printing Specifications” on page 90 for further information about the ranges available for your model. Print width determines the printable area across the width of the label.</p> <p>NOTE: The printer does not accept any value larger than the maximum print width listed on page 90.</p>
	MAXIMUM LENGTH	<p>Setting Maximum Length: Press the LEFT BLACK OVAL key to decrease the value, press the RIGHT BLACK OVAL key to increase the value.</p> <p>Default; Range: The default and range of acceptable values vary depending on your printer’s configuration. Values are adjustable in 1" (25.4 mm) increments.</p> <p>Maximum length is used in conjunction with the calibration procedure. The value of this setting is the maximum label length that is used during the media portion of the calibration process. Only a few labels are required to set media sensors. Always set the value that is at least 1" longer than the longest label to be used on the printer.</p>

Listing Printer Information		
Press	Display Shows	Action/Explanation
	LIST FONTS	List Fonts: Press the RIGHT BLACK OVAL key to print a label listing all of the available fonts. This selection is used to print a label that lists all of the fonts currently available in the printer, including standard printer fonts plus any optional fonts. Fonts may be stored in RAM, FLASH memory, font EPROMs, or font cards.
	LIST BAR CODES	List Bar Codes: Press the RIGHT BLACK OVAL key to print a label listing all of the available bar codes. This selection is used to print a label that lists all of the bar codes currently available in the printer.
	LIST IMAGES	List Images: Press the RIGHT BLACK OVAL key to print a label listing all of the available images. This selection is used to print a label that lists all of the images currently stored in the printer's RAM, FLASH memory, optional EPROM, or optional memory card.
	LIST FORMATS	List Formats: Press the RIGHT BLACK OVAL key to print a label listing all of the available formats. This selection is used to print a label that lists all of the formats currently stored in the printer's RAM, FLASH memory, optional EPROM, or optional memory card.
	LIST SETUP	List Setup: Press the RIGHT BLACK OVAL key to print a label listing the current printer configuration. This selection is used to print a label that lists the current printer configuration information. (Same as the CANCEL key self test.)
	LIST ALL	List All: Press the RIGHT BLACK OVAL key to print a label listing all of the available fonts, bar codes, images, formats, and the current printer configuration. This selection is used to print a label that lists the five previous selections, as described.

Press	Display Shows	Action/Explanation
	INITIALIZE CARD	<p>Initialize Memory Card CAUTION: Perform this operation only when it is necessary to erase all previously stored information from the optional memory card (for printers with a PCMCIA slot [part # 32091]). Press the NEXT/SAVE key to bypass this function.</p> <ol style="list-style-type: none"> 1. Press the RIGHT BLACK OVAL key to select "YES." If your printer is set to require a password, you are now prompted to enter the password. Enter the password and then press the NEXT/SAVE key. 2. The display asks "INITIALIZE CARD?". Press the RIGHT BLACK OVAL key "YES." 3. The front panel LCD asks "ARE YOU SURE?". 4. Press the RIGHT BLACK OVAL key "YES" to begin initialization. <i>or</i> Press the LEFT BLACK OVAL key "NO" to cancel the request and return to the "INITIALIZE CARD" prompt. 5. Press the SETUP/EXIT key followed by the NEXT/SAVE key. If initialization is still in process, the front panel display flashes back and forth between the two phrases "CHECKING B: MEMORY" and "PRINTER IDLE." When initialization is complete, the printer automatically exits the configuration mode and the front panel displays "PRINTER READY." <p>NOTE: Depending on the amount of memory in the memory card, initialization may take up to five minutes to complete.</p>
	INIT FLASH MEM	<p>Initialize Flash Memory CAUTION: Perform this operation only when it is necessary to erase all previously stored information from the FLASH memory. Press the NEXT/SAVE key to bypass this function.</p> <ol style="list-style-type: none"> 1. Press the RIGHT BLACK OVAL key to select "YES." If your printer is set to require a password, you are now prompted to enter the password. Enter the password and then press the NEXT/SAVE key. 2. The display asks "INITIALIZE FLASH?". Press the RIGHT BLACK OVAL key "YES." 3. The front panel LCD asks "ARE YOU SURE?". 4. Press the RIGHT BLACK OVAL key "YES" to begin initialization. <i>or</i> Press the LEFT BLACK OVAL key "NO" to cancel the request and return to the "INITIALIZE FLASH" prompt.

Media and Ribbon Sensor Calibration

NOTE: Before you begin this procedure, make sure that the maximum length is set to a value 1" greater than the length of the labels you are using. If the maximum length is set to a lower value, the calibration process assumes that continuous media is in the printer. See page 46 for more information.

There are two different types of calibration that can be performed by the printer:

1) Standard Calibration. When the printer is first powered up and after the print head has been closed, the printer feeds media and automatically sets the value it detects for media, media backing material (the spaces between labels), and media out. This type of calibration also occurs as part of the sensor profile and media and ribbon calibration procedures.

2) Media and Ribbon Sensor Sensitivity Calibration. Performing the media and ribbon calibration procedure first resets the sensitivity of the sensors to better detect the media and ribbon you are using. With the sensors at their new sensitivity, the printer then performs the standard calibration. Changing the type of ribbon and/or media may require resetting the sensitivity of the media and ribbon sensors. Indications that the sensitivity may need to be reset would be a CHECK RIBBON light on with the ribbon properly installed or non-continuous media being treated as continuous media.

Press	Display Shows	Action/Explanation
	<p>SENSOR PROFILE</p>	<p>Sensor Profile: Press NEXT/SAVE to skip this standard calibration procedure and continue with the media and ribbon calibration parameter which follows. Press the RIGHT BLACK OVAL key to initiate this standard calibration procedure and print a media sensor profile.</p> <p>See Figure 26. The media sensor profile may be used to troubleshoot registration problems that may be caused when the media sensor detects preprinted areas on the media or experiences difficulty in determining web location. If the sensitivity of the media and/or ribbon sensors MUST be adjusted, use the media and ribbon sensor sensitivity procedure.</p>

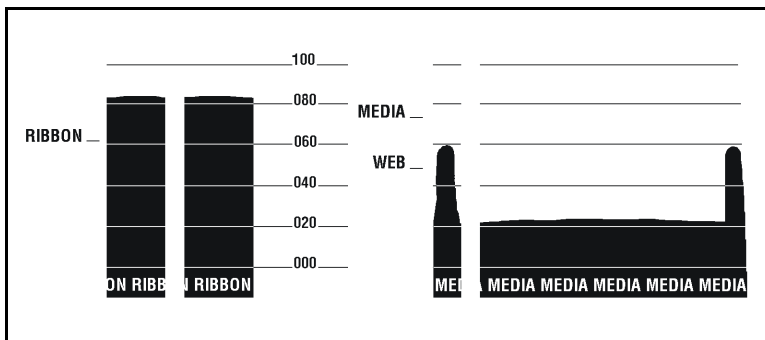















Figure 26



Press	Display Shows	Action/Explanation
	MEDIA AND RIBBON CALIBRATE	<p>Media and Ribbon Sensor Sensitivity: Press NEXT/SAVE to skip the calibration procedure and continue with the host port selection parameters that follow. Press the RIGHT BLACK OVAL key to start the calibration procedure. This procedure is used to adjust the sensitivity of the media and ribbon sensors.</p> <p>NOTE: The procedure must be followed exactly as presented. All steps must be performed even if only one of the sensors requires adjustment.</p>
Media and Ribbon Calibration Procedure		
	LOAD BACKING	<p>Press the LEFT BLACK OVAL key to cancel the operation, or do the following:</p> <ol style="list-style-type: none"> 1) Open the printhead. 2) Remove approximately 8" (203 mm) of labels from the media roll, and pull the backing into the printer so that only the backing is between the media sensors. 3) Press the RIGHT BLACK OVAL key to continue.
	REMOVE RIBBON	<p>Press the LEFT BLACK OVAL key to cancel the operation or do the following:</p> <ol style="list-style-type: none"> 1) Remove the ribbon. 2) Close the printhead. 3) Press the RIGHT BLACK OVAL key to continue.
	CALIBRATING PLEASE WAIT	The printer automatically adjusts the scale (gain) of the signals it receives from the media and ribbon sensors. On the sensor profile, this essentially corresponds to moving the peak of the graph up or down to optimize the readings for your application.
—	RELOAD ALL	<p>When "RELOAD ALL" is displayed:</p> <ol style="list-style-type: none"> 1) Open the printhead and pull the media forward until a label is positioned under the media sensor. 2) Reload the ribbon back into to its proper position. 3) Close the printhead. 4) Press the RIGHT BLACK OVAL key to continue.
	MEDIA AND RIBBON CALIBRATE	Now that the scale has changed, the printer performs a calibration equivalent to pressing the CALIBRATE key; during this process, the printer determines the label length. The process is now complete! To see the new readings on the new scale, print a sensor profile.

Setting Communication Parameters

Communication parameters must be set correctly for the printer to communicate with the host computer. These parameters make sure that the printer and host computer are “speaking the same language.” All communications parameters are password protected.

Press	Display Shows	Action/Explanation
	PARALLEL COMM	Setting Parallel Communications: Press the RIGHT or LEFT BLACK OVAL key to display other choices. Default: Parallel Selections: Parallel, twinax/coax Select the communications port that matches the one being used by the host computer.
	SERIAL COMM	Setting Serial Communications: Press the RIGHT or LEFT BLACK OVAL key to display other choices. Default: RS-232 Selections: RS-232, RS-422/485, RS-485 multidrop Select the communications port that matches the one being used by the host computer.
	BAUD	Setting Baud: Press the RIGHT or LEFT BLACK OVAL key to display other choices. Default: 9600 Selections: 110, 300, 600, 1200, 2400, 4800, 9600, 14400, 19200, 28800, 38400, 57600 The baud setting of the printer must match the baud setting of the host computer for accurate communications to take place. Select the value that matches the one being used by the host computer.
	DATA BITS	Setting Data Bits: Press the RIGHT or LEFT BLACK OVAL key to display other choices. Default: 7-bits Selections: 7-bits, 8-bits The data bits of the printer must match the data bits of the host computer for accurate communications to take place. Set the data bits to match the setting being used by the host computer. NOTE: Must be set to 8 data bits to use Code Page 850.



Press	Display Shows	Action/Explanation
	PARITY	<p>Setting Parity: Press the RIGHT or LEFT BLACK OVAL key to display other choices. Default: Even Selections: Even, odd, none</p> <p>The parity of the printer must match the parity of the host computer for accurate communications to take place. Select the parity that matches the one being used by the host computer.</p>
	STOP BITS	<p>Setting Stop Bits: Press the RIGHT or LEFT BLACK OVAL key to display other choices. Default: 1 stop bit Selections: 1 stop bit, 2 stop bits</p> <p>The stop bits of the printer must match the stop bits of the host computer for accurate communications to take place. Select the stop bits that match the one being used by the host computer.</p>
	HOST HANDSHAKE	<p>Setting Host Handshake: Press the RIGHT or LEFT BLACK OVAL key to display other choices. Default: XON/XOFF Selections: XON/XOFF, DTR/DSR</p> <p>The handshake protocol of the printer must match the handshake protocol of the host computer for proper communications to take place. Select the handshake protocol that matches the one being used by the host computer.</p>
	PROTOCOL	<p>Setting Protocol: Press the RIGHT or LEFT BLACK OVAL key to display other choices. Default: None Selections: None, Zebra, ACK/NACK</p> <p>Protocol is a type of error checking system. Depending on the selection, an indicator may be sent from the printer to the host computer signifying that data has been received. Select the protocol that is requested by the host computer. Further details on protocol can be found in the <i>ZPL II Programming Guide</i>.</p> <p>NOTE: Zebra is the same as ACK/NACK except that with Zebra the response messages are sequenced. If Zebra is selected, printer must use "DTR/DSR" host handshake protocol.</p>



Press	Display Shows	Action/Explanation
	NETWORK ID	<p>Setting Network ID: Press the LEFT BLACK OVAL key to move to the next digit position, press the RIGHT BLACK OVAL key to increase the value of the digit. Default: 000 Range: 000 - 999</p> <p>Network ID is used to assign a unique number to a printer used in an RS-422/RS-485 network. This gives the host computer the means to address a specific printer. If the printer is used in a RS-422/RS-485 network, you must select a network ID number. This does not affect TCP/IP or IPX networks.</p>
	COMMUNICATIONS	<p>Setting Communications Mode: Press the RIGHT or LEFT BLACK OVAL key to display other choices. Default: Normal mode Selections: Normal mode, diagnostics</p> <p>The communication diagnostics mode is a troubleshooting tool for checking the interconnection between the printer and the host computer. When “diagnostics” is selected, all data sent from the host computer to the printer is printed as straight ASCII characters, with the hex value below the ASCII text. The printer prints all characters received including control codes, like CR (carriage return). A sample printout is shown in Figure 36 on page 85.</p> <p>NOTES on diagnostic printouts:</p> <ul style="list-style-type: none"> • FE indicates a framing error. • OE indicates an overrun error. • PE indicates a parity error. • NE indicates noise. <p>For any errors, check that your communication parameters are correct. Set the print width equal to or less than the label width used for the test. See page 46 for more information.</p>

Selecting Prefix and Delimiter Characters



Prefix and delimiter characters are 2-digit hex values used within the ZPL/ZPL II formats sent to the printer. The printer uses the last prefix and delimiter characters sent to it, whether from a ZPL II instruction or from the front panel.



NOTE: DO NOT use the same hex value for the control, format, and delimiter character. The printer needs to see different characters to function properly.









Press	Display Shows	Action/Explanation
	CONTROL PREFIX	<p>Control Prefix Character: Press the LEFT BLACK OVAL key to move to the next digit position, press the RIGHT BLACK OVAL key to increase the value of the digit.</p> <p>Default: 7E (tilde - displayed as a black square)</p> <p>Range: 00-FF</p> <p>The printer looks for this 2-digit hex character to indicate the start of a ZPL/ZPL II control instruction.</p>
	FORMAT PREFIX	<p>Format Prefix Character: Press the LEFT BLACK OVAL key to move to the next digit position, press the RIGHT BLACK OVAL key to increase the value of the digit.</p> <p>Default: 5E (caret)</p> <p>Range: 00 - FF</p> <p>The printer looks for this 2-digit hex character to indicate the start of a ZPL/ZPL II format instruction.</p>
	DELIMITER CHAR	<p>Delimiter Character: Press the LEFT BLACK OVAL key to move to the next digit position, press the RIGHT BLACK OVAL key to increase the value of the digit.</p> <p>Default: 2C (comma)</p> <p>Range: 00 - FF</p> <p>The delimiter character is a 2-digit hex value used as a parameter place marker in ZPL/ZPL II format instructions. Refer to the <i>ZPL II Programming Guide Volume I</i> for more information.</p>



Selecting ZPL Mode		
Press	Display Shows	Action/Explanation
	ZPL MODE	<p>Selecting ZPL Mode: Press the RIGHT or LEFT BLACK OVAL key to display other choices.</p> <p>Default: ZPL II</p> <p>Selections: ZPL II, ZPL</p> <p>The printer remains in the selected mode until it is changed by this front panel instruction or by using a ZPL/ZPL II command. The printer accepts label formats written in either ZPL or ZPL II. This eliminates the need to rewrite any ZPL formats you already have. Refer to the <i>ZPL II Programming Guide</i> for more information on the differences between ZPL and ZPL II.</p>
Power-Up and Head Close Parameters		
	MEDIA POWER UP	<p>Media Power-Up: Press the RIGHT or LEFT BLACK OVAL key to display other choices.</p> <p>Default: Calibration</p> <p>Selections: Feed, calibration, length, and no motion</p> <p>This parameter establishes the action of the media when the printer is turned on.</p> <ul style="list-style-type: none"> • Calibration: Determines the length of the label. • Feed: Feeds the label to the first registration point. • Length: Used in continuous mode to feed the last stored label length. • No Motion: Media does not move.
	HEAD CLOSE	<p>Head Close: Press the RIGHT or LEFT BLACK OVAL key to display other choices.</p> <p>Default: Calibration</p> <p>Selections: Feed, calibration, length, no motion</p> <p>Determines the action of the media after the printhead has been opened and then closed.</p> <ul style="list-style-type: none"> • Calibration: Determines the length of the label. • Feed: Feeds the label to the first registration point. • Length: Used in continuous mode to feed the last stored label length. • No Motion: Media does not move.





Label Positioning Parameters

Press	Display Shows	Action/Explanation
	BACKFEED	<p>Backfeed Sequence: Press the RIGHT or LEFT BLACK OVAL key to display other choices. Default: Default (90%) Selections: Default, after, before, 10%, 20%, 30%, 40%, 50%, 60%, 70%, 80%, off</p> <p>This parameter establishes when and how much label backfeed occurs after a label is removed or cut in the peel-off, cutter, and applicator modes. It has no effect in rewind or tear-off modes. This parameter setting can be superseded by the ~JS instruction when received as part of a label format (refer to the <i>ZPL II Programming Guide</i>).</p> <p>NOTE: The difference between the value entered and 100% establishes how much backfeed occurs before the next label is printed. For example, a value of 40 means that 40% of the backfeed takes place after the label is removed or cut. The remaining 60% takes place before the next label is printed. A value of "before" means that all backfeed takes place before the next label is printed.</p>
	LABEL TOP	<p>Adjusting Label Top Position: Press the RIGHT BLACK OVAL key to increase the value, press the LEFT BLACK OVAL key to decrease the value. The displayed value represents dots. Default: +0 Range: -120 to +120 dot rows</p> <p>The label top position adjusts the print position vertically on the label. Positive numbers adjust the label top position further down the label (away from the printhead), negative numbers adjust the position up the label (toward the printhead).</p>
	LEFT POSITION	<p>Adjusting Left Position: Press the LEFT BLACK OVAL key to move the cursor, press the RIGHT BLACK OVAL key to change between + and - and to increase the value of the digit. The displayed value represents dots. Default: 0000 Range: -9999 to +9999</p> <p>NOTE: For a negative value, enter the value before changing to the minus sign.</p> <p>This parameter establishes how far from the left edge of a label the format begins to print by adjusting horizontal positioning on the label. Positive numbers adjust the printing to the left by the number of dots selected, negative numbers shift printing to the right.</p>





Press	Display Shows	Action/Explanation
	HEAD TEST COUNT	<p>Setting the Head Test Count: Press the LEFT BLACK OVAL key to move the cursor, press the RIGHT BLACK OVAL key to change the value of the digit. Default: 0000 (disables the test) Range: 0000 to 9999</p> <p>The printer periodically performs a test of the printhead functionality, called a “printhead test” or “head test.” This parameter establishes how many labels are printed between these internal tests.</p>
	HEAD RESISTOR	<p>Setting the Head Resistor Value: Press the LEFT BLACK OVAL key to move the cursor, press the RIGHT BLACK OVAL key to increase the value of the digit. CAUTION: This parameter should only be changed by qualified personnel! Initial Value: Factory-set to match the printhead shipped with your printer. Default Value: 0500 Range: 0500 to 1175</p> <p>This value has been pre-set at the factory to match the resistance value of the printhead. It does not need to be changed unless the printhead is replaced or the main logic board is replaced. CAUTION: DO NOT set the value higher than that shown on the printhead. Setting a higher value may damage the printhead!</p> <p>Before replacing a printhead, look on the printhead for the label that shows the resistance value (ohm value).</p>
	VERIFIER PORT	<p>Setting the Verifier Port: Press the RIGHT or LEFT BLACK OVAL key to display other choices. Default: Off Selections: Off, 1 VER-RPRNT, 2 VER-THRUPUT</p> <p>The auxiliary port is used to determine how the printer reacts to the on-line verifier. There are currently three operating conditions for this port:</p> <ul style="list-style-type: none"> • Off: The verifier port is off. • 1 VER-RPRNT ERR: Label reprinted if verifier detects an error. If a bar code is near the upper edge of the label, the label is fed out far enough to be verified and then backfed to allow the next label to be printed and verified. • 2 VER-THRUPUT: Allows greatest throughput but may not indicate a verification error immediately upon detection. May print from one to three labels before an error is recognized and printing stops. <p>For more information on the operation of the optional verifier, refer to the documentation provided with that option.</p>

Press	Display Shows	Action/Explanation
	APPLICATOR PORT	<p>Setting the Applicator Port: Press the RIGHT or LEFT BLACK OVAL key to display other choices.</p> <p>Default: Off</p> <p>Selections: Off, mode 1, mode 2, mode 3, mode 4 Determines the action of the verifier port.</p> <ul style="list-style-type: none"> • Off: The applicator port is off. • Mode 1: Asserts the \simEND_PRINT signal low while the printer is moving the label forward. • Mode 2: Asserts the \simEND_PRINT signal high while the printer is moving the label forward. • Mode 3: Asserts the \simEND_PRINT signal low for 20 milliseconds when a label has been completed and positioned. Not asserted during continuous printing modes. • Mode 4: Asserts the \simEND_PRINT signal high for 20 milliseconds when a label has been completed and positioned. Not asserted during continuous printing modes. <p>NOTE: Set as suggested by the applicator manufacturer.</p>
	WEB S.	<p>These parameters are automatically set during the calibration procedure. They should only be changed by a qualified service technician. Refer to the maintenance manual for more information on these parameters.</p> <p>Press the NEXT/SAVE key repeatedly to skip these parameters.</p>
	MEDIA S.	
	RIBBON S.	
	MARK S.	
	MARK MED S.	
	MEDIA LED	
	RIBBON LED	
	MARK LED	



Press	Display Shows	Action/Explanation
	START PRINT SIG	<p>Start Print Signal: Press the RIGHT or LEFT BLACK OVAL key to display other choices. Default: Pulse Mode Selections: Pulse Mode, Level Mode</p> <p>This parameter determines how the printer reacts to the Start Print Signal input on pin 3 of the applicator interface connector at the rear of the printer.</p> <ul style="list-style-type: none"> • In Pulse Mode, labels print when the signal transitions from HIGH to LOW. • In Level Mode, labels print as long as the signal is asserted LOW. <p>CAUTION: Start Print Signal is set by the applicator manufacturer and should not be changed unless the factory defaults have been reloaded. Please make a note of it! While other choices are valid, the printer must be returned to its designated setting in order for it to work properly.</p>
	RESYNCH MODE	<p>Resynch Mode: Press the RIGHT or LEFT BLACK OVAL key to display other choices. Default: Feed Mode Selections: Feed Mode, Error Mode</p> <p>This parameter determines how the printer reacts if the label synchronization is lost and the label top is not where expected.</p> <p>FEED MODE — If the label top is not where expected, the printer feeds a blank label to find the label top position.</p> <p>ERROR MODE — If the label top is not where expected, the printer stops, enters the PAUSE mode, displays the message “Error Condition Feed Label”, flashes the ERROR LED, and asserts the “Service Required” signal (pin 10 on the Applicator Interface Connector).</p> <p>To resynch the media to the top of the label in this mode, press the PAUSE key to exit the PAUSE state. The ERROR LED stops flashing and the “Service Required” signal is deactivated. The action of the printer is determined by the “Head Close” configuration selection:</p> <ul style="list-style-type: none"> • “Calibration” — determines the length of the label. • “Feed” — feeds the labels to the first registration point. • “Length” — used in continuous mode to feed the last stored label length. • “No Motion” — the media does not move. The user must press the FEED key to cause the printer to resynch to the start of the next label.

Press	Display Shows	Action/Explanation
	LCD ADJUST	<p>LCD Display Adjustment: Press the LEFT BLACK OVAL key to decrease the value (reduce contrast), press the RIGHT BLACK OVAL key to increase the value (increase contrast). Range: 00 to 19 This parameter allows you to adjust the contrast of your display if your display is difficult to read.</p>
	FORMAT CONVERT	<p>Format Convert: Press the RIGHT or LEFT BLACK OVAL key to display other choices. Default: None Selections: None, 150 → 300, 150 → 600, 200 → 600, 300 → 600 Selects the bitmap scaling factor. The first number is the original dots per inch (dpi) value; the second, the dpi to which you would like to scale. NOTE: Not applicable on all printers.</p>
	IDLE DISPLAY*	<p>Idle Display: Press the RIGHT or LEFT BLACK OVAL key to display other choices. Default: Firmware version Selections: mm/dd/yy (24 hour), mm/dd/yy (12 hour), dd/mm/yy (24 hour), dd/mm/yy (12 hour) This parameter selects the LCD display options for the real time clock (if installed). NOTE: If the default value is not selected, pressing either BLACK OVAL key briefly displays the firmware version of the printer.</p>
	RTC DATE*	<p>RTC (Real Time Clock) Date: Press the LEFT BLACK OVAL key to move to the next digit position, press the RIGHT BLACK OVAL key to increase the value of the digit. This parameter allows you to set the date following the convention selected in "IDLE DISPLAY."</p>
	RTC TIME*	<p>RTC (Real Time Clock) Time: Press the LEFT BLACK OVAL key to move to the next digit position, press the RIGHT BLACK OVAL key to increase the value of the digit. This parameter allows you to set the time following the convention selected in "IDLE DISPLAY."</p>

* Real Time Clock option required

Press	Display Shows	Action/Explanation
	IP RESOLUTION*	<p>IP Resolution: Press the RIGHT or LEFT BLACK OVAL key to display other choices. Default: Dynamic Selections: Dynamic, permanent Depending on the selection, allows either the user ("permanent") or the server ("dynamic") to select the IP address. For more information, refer to <i>ZebraNet Networking: PrintServer II Installation and User's Guide</i>.</p>
	IP PROTOCOLS*	<p>IP Protocols: Press the RIGHT or LEFT BLACK OVAL key to display other choices. Default: All Selections: All, gleaning only, RARP, BOOTP, DHCP, DHCP/BOOTP If "dynamic" was chosen in the previous parameter, this selection determines the method(s) by which the PrintServer II receives the IP address from the server. For more information, refer to <i>ZebraNet Networking: PrintServer II Installation and User's Guide</i>.</p>
	IP ADDRESS*	<p>IP Address: Press the LEFT BLACK OVAL key to move to the next digit position, press the RIGHT BLACK OVAL key to increase the value of the digit. This parameter allows you to select the IP address if "permanent" was chosen in "IP RESOLUTION." (If "dynamic" was chosen, the user cannot select the address.) For more information, refer to <i>ZebraNet Networking: PrintServer II Installation and User's Guide</i>.</p>
	SUBNET MASK*	<p>Subnet Mask: Press the RIGHT or LEFT BLACK OVAL key to display other choices. Default: Permanent (user <i>must</i> set) Selections: Dynamic (user <i>may</i> set, but server can assign), permanent This parameter selects the part of the IP address that is considered to be part of the local network. It can be reached without going through the default gateway.</p>
	DEFAULT GATEWAY*	<p>Default Gateway: Press the LEFT BLACK OVAL key to move to the next digit position, press the RIGHT BLACK OVAL key to increase the value of the digit. This parameter allows you to select the IP address that the network traffic is routed through if the destination address is not part of the local network.</p>

* ZebraNet® PrintServer II option required

Press	Display Shows	Action/Explanation
	LANGUAGE	<p>Selecting the Display Language: Press the RIGHT or LEFT BLACK OVAL key to display other choices.</p> <p>Default: English</p> <p>Selections: English, Spanish, French, German, Italian, Norwegian, Portuguese, Swedish, Danish, Spanish 2, Dutch, Finnish, Japanese</p> <p>This parameter allows you to change the language used on the front panel display.</p>
You have now completed the entire configuration and calibration sequence. You may either press the NEXT/SAVE key or the SETUP/EXIT key.		
	DARKNESS	<p>You are now back at the first parameter in the configuration sequence.</p> <p>NOTE: If you pressed the NEXT/SAVE key but are through programming the printer configuration, you may press the SETUP/EXIT key and continue with the "SAVE SETTINGS" function.</p>
	SAVE SETTINGS	<p>Save Settings: Press the RIGHT or LEFT BLACK OVAL key to display other choices.</p> <p>Default: Permanent</p> <p>Selections: Permanent, temporary, cancel, load defaults, load last save.</p> <p>This display appears when you attempt to exit the configuration mode.</p> <ul style="list-style-type: none"> • Permanent: Permanently saves the changes, even when printer power is turned off. • Temporary: Saves the changes until changed again or until power is turned off. • Cancel: Cancels all changes since you entered the configuration mode except for darkness and tear-off position (if they were changed). • Load defaults: Loads factory defaults. <p>NOTE: Loading factory defaults requires calibration.</p> <ul style="list-style-type: none"> • Load last save: Loads the values from the last permanent save.
—	PRINTER READY	You have exited the configuration and calibration sequence and are now ready for normal printer operation.

Routine Care and Adjustment

Cleaning

The following table provides a brief cleaning schedule. Specific cleaning procedures are provided on the following pages.

Area	Method	Interval
Printhead	Solvent*	Direct thermal print mode: After every roll of media (or 500'/152 m of fanfold media).
Platen roller	Solvent*	
Transmissive sensor	Air blow	
Black mark sensor	Air blow	Thermal transfer print mode: After every roll of ribbon.
Media path	Solvent*	
Ribbon sensor	Air blow	
Label available sensors	Air blow	Monthly
Tear-off/peel-off bar	Solvent*	As needed
Snap plate	Solvent*	
Cutter	Solvent*	

* Zebra recommends using isopropyl alcohol.

CAUTION: *Use only the cleaning agents indicated. Zebra Technologies Corporation is not responsible for damage caused by any other fluids being used on this printer.*

Cleaning the Exterior

The exterior surfaces of the printer may be cleaned with a lint-free cloth. Do not use harsh or abrasive cleaning agents or solvents. If necessary, a mild detergent solution or desktop cleaner may be used sparingly.

Cleaning the Interior

Inspect this area after every four rolls of media. Remove any dirt and lint from the interior of the printer using a soft bristle brush and/or vacuum cleaner.

Cleaning the Printhead and Platen Roller

Inconsistent print quality, such as voids in the bar code or graphics, may indicate a dirty printhead. For best results, perform the following cleaning procedure after every roll of ribbon.

NOTE: You do not need to turn off the printer before cleaning the printhead. If power is turned off, all label formats and images, as well as any temporarily saved parameter settings stored in the printer's internal memory, are lost. When power is turned back on, you need to reload these items.

To clean the printhead, refer to Figure 27 and follow these steps:

1. Open the printhead.
2. Remove the media and ribbon (if loaded).
3. Moisten an applicator tip with solvent and wipe along the print elements from end to end. (The print elements are on the brown strip just behind the chrome strip on the printhead.) Allow a few seconds for the solvent to evaporate.

4. Rotate the platen roller and clean thoroughly with solvent and an applicator.
5. Brush/vacuum any accumulated paper lint and dust away from the rollers.
6. Reload ribbon and/or media, and close the printhead.

NOTE: If print quality has not improved after performing this procedure, try cleaning the printhead with Save-a-Printhead cleaning film. This specially-coated material removes contamination buildup without damaging the printhead. Call your authorized Zebra reseller/distributor for more information.

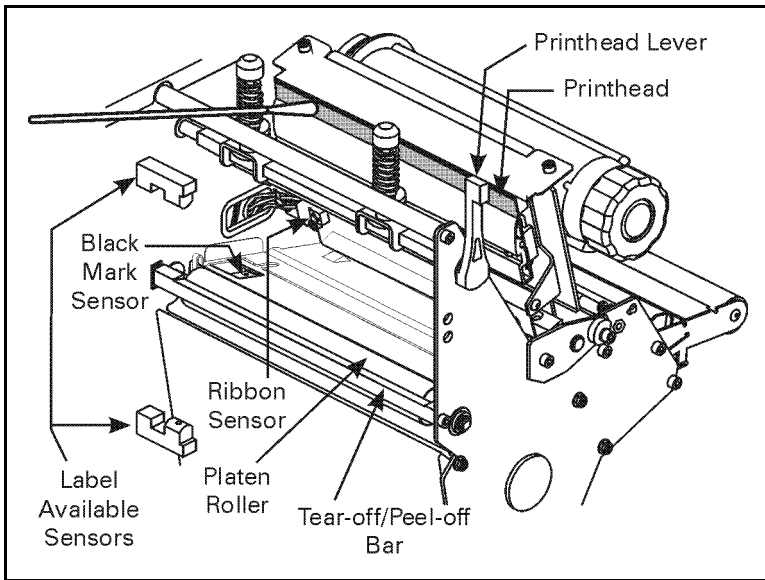

Figure 27

Extend the Life of Your Printhead With *Save-A-Printhead* Cleaning Film

Challenge

The printhead is the most critical component in your printer, and possibly the most delicate. It is a consumable item just like the brakes on your car, which eventually wears over time. However, with ongoing careful attention and maintenance, you can extend the life of the printhead!

Below are photographs of three printheads. The first printhead is brand new. The second has printed over 1 million linear inches of thermal transfer labels and has been properly maintained. The third printhead has printed far fewer labels, but without proper care and maintenance, signs of abrasion and contamination build-up are evident.



Preventive Maintenance

For optimum performance, clean the printhead regularly after every roll of thermal transfer ribbon or after every roll of direct thermal labels. Take care when handling or cleaning the printhead by removing any jewelry that may scratch the printhead and use a grounding strap or anti-static mat to discharge static electricity that could damage the printhead.

To start, only use the pre-soaked (isopropyl alcohol) cleaning swabs provided in the preventive maintenance kit. First, turn off the printer and open the printhead. Lightly blow or brush away any loose dust and lint particles within the print mechanism (i.e., rollers, media/ribbon sensors, and printhead). NEVER use any hard, metallic, or abrasive objects — such as a screwdriver — to remove adhesives or other contaminants that may have built up on the printhead.

Next, press the swab tip against the printhead and swipe the print elements from end to end. Then, turn the platen rollers while wiping them from side to side. Repeat this step until the swab no longer shows dirt.

Avoid the Contributing Factors to Premature Printhead Failure

Abrasion- Over time, the movement of media/ribbon across the printhead wears through the protective ceramic coating, exposing and eventually damaging the print elements (dots).

In order to avoid abrasion:

- Clean your printhead frequently and use well-lubricated thermal transfer ribbons with backcoatings optimized to reduce friction.
- Minimize printhead pressure and burn temperature settings by optimizing the balance between the two.
- Ensure that the thermal transfer ribbon is as wide or wider than the label media to prevent exposing the elements to the more abrasive label material.

Ribbon Backcoating and Buildup- Printhead contamination from direct thermal media or thermal transfer ribbon may occur in applications requiring high burn settings, high head pressure, high speed, or high volume. This contamination builds up on the printhead elements, creating a barrier to the heat transformation required to produce high quality images. Contaminant buildup occurs gradually and results in poor print quality that may look like faded print or failed print element(s). This build up is very resistant to cleaning with the pre-soaked swabs and is difficult to remove.

In order to avoid ribbon backcoating and buildup:

- Use thermal transfer ribbons that have been specially cured to provide backcoat protection for high demand applications. These ribbons — sometimes referred to as anti-stick ribbons — also dissipate static and provide more lubrication.
- Follow the recommended Printhead Preventive Maintenance procedures.
- Use our *Save-a-Printhead* cleaning film to remove printhead contamination buildup quickly and easily.

***Save-a-Printhead* Cleaning Film**

What is *Save-a-Printhead* cleaning film? A specially coated film that removes contamination buildup without damaging the printhead.

What are the benefits of *Save-a-Printhead* cleaning film?

- Extends the life of your printhead.
- Reduces maintenance downtime and the cost of replacing a printhead.
- An inexpensive, easy and quick way to remove contaminants without having to remove the printhead.

When should you use *Save-a-Printhead* cleaning film? When you see degrading print quality that looks like faded print or a failed print element(s) that cannot be corrected by cleaning with the pre-soaked cleaning swabs.

How to Use *Save-a-Printhead* Cleaning Film

1. Remove power from the printer.
2. Open the printhead, remove media and ribbon from the print mechanism.
3. Clean the printhead per the recommended Preventive Maintenance procedures.
4. Position the *Save-a-Printhead* film in the print path, placing the glossy side down away from the printhead (matte side up).
5. Close and latch the printhead.
6. Slowly pull the full length of the film through the print mechanism.
7. Again, clean the printhead per the recommended Preventive Maintenance procedures.
8. Reload media and ribbon, close and latch the printhead.
9. Print labels and inspect for improved print quality. If quality has not improved, contact our Technical Support staff.

*Only one pass is required to remove contamination buildup.

*Each strip of film can be used up to 10 times.

*Discard the strip when residue buildup or other contamination is apparent.

NOTE: In the case that a replacement printhead is needed, product from the Original Equipment Manufacturer (OEM) is strongly recommended to ensure that your printer and part warranties remain intact, and that the product performs optimally.

How to Order *Save-a-Printhead* Cleaning Film Kits

There are five kits to accommodate the different width printers. Each kit contains three 10" long strips of film. Reference the following table to order the kit for your printer:

<u>Order kit number:</u>	<u>For Printers with Print Widths:</u>
46902	3.0"-4.0"
44902	4.0"-5.0"
48902	5.0"-6.0"
38902	6.0"-7.0"
22902	8.0"-9.0"

Cleaning the Sensors

The media, ribbon, and label available sensors should be cleaned on a regular basis to ensure proper operation of the printer. To locate these sensors, refer to Figure 27 on page 65, Figure 6 on page 11, and Figure 7 on page 12. Brush/vacuum any accumulated paper lint and dust off of these sensors.

Cleaning the Snap Plate

Clean the snap plate to remove label adhesive or a label that has adhered to the underside of the snap plate.

Refer to Figure 28.

1. Insert a small-blade screwdriver or similar tool into the loop on the left side of the snap plate. Lift the snap plate.

CAUTION: Take care not to bend, twist, or otherwise deform the loops!

2. Repeat step one on the right side of the snap plate.
3. Remove the snap plate from the printer.
4. Clean the snap plate with cleaning solvent and a soft cloth.

Refer to Figure 29.

5. To reinstall the snap plate, insert the two tabs on the bottom of the snap plate into the two slots of the media pathway.
6. Slide the snap plate toward you.
7. Press down on the loops to lock the snap plate into place.

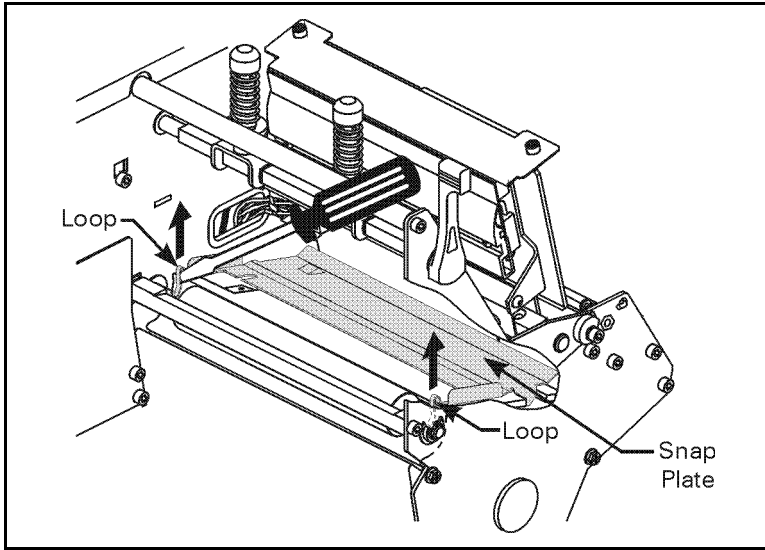

Figure 28

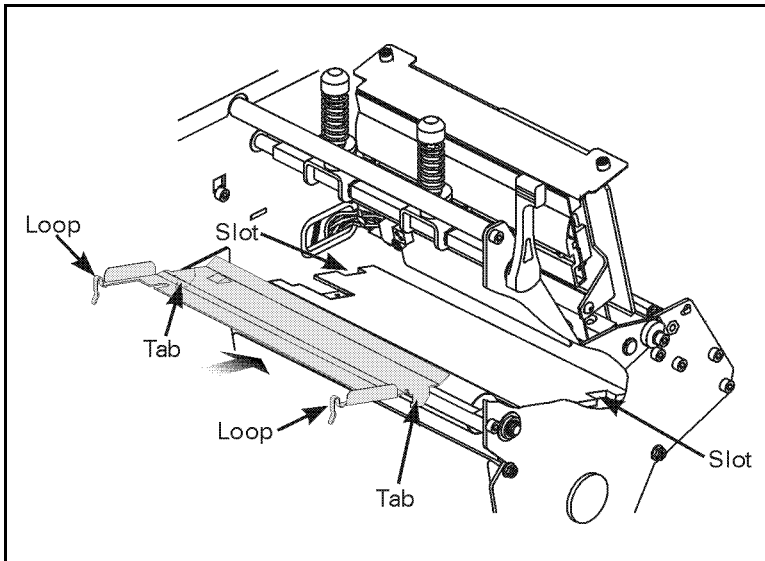

Figure 29

Cleaning the Cutter Module

(For printers equipped with the optional cutter.)

If labels are not being cut properly or if the cutter jams with labels, turn off the printer power and unplug the printer. Then, clean the stationary cutter blade with cleaning solvent. This removes label adhesive and/or paper debris. If further cutter cleaning is necessary, or if the cutter continues to perform unsatisfactorily, contact an authorized service technician.

Lubrication

CAUTION! No lubricating agents of any kind should be used on this printer! Some commercially available lubricants will damage the finish and the mechanical parts if used.

Fuse Replacement

The printer uses a metric-style fuse (5 x 20 mm IEC) rated at F5A, 250V. The end caps of the fuse must bear the certification mark of a known international safety organization (see Figure 38 on page 92). The printer comes with two approved fuses: one in the circuit and one in the “spare fuse” holder.

1. Turn off the printer power and unplug the power cord from the back of the printer. See Figure 30.
2. Using a small-blade screwdriver or similar tool, remove the fuse holder from the printer.
3. Remove the faulty fuse and install a new fuse of the correct type. Refer to Figure 31. The fuse that goes into the printer first is the one that is “in-circuit.” If you use the spare fuse, be sure to order a replacement fuse (fuses can be ordered from your Zebra distributor).

4. Snap the fuse holder back into position.
5. Reconnect the power cord.

NOTE: If the new fuse fails right away, the printer has an internal component failure and must be repaired.

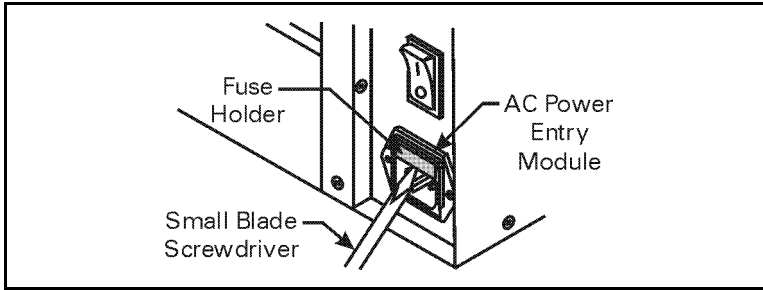

Figure 30

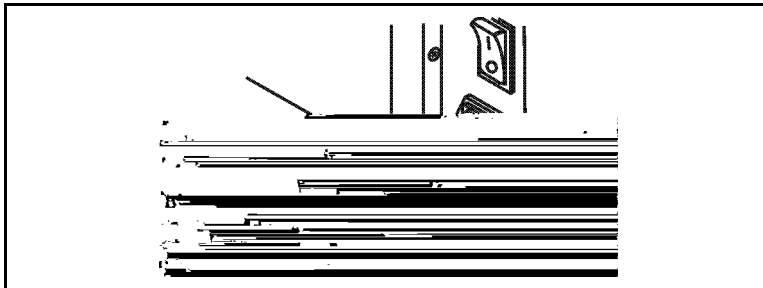

Figure 31

Adjustments

Toggle Positioning

Both toggles should be positioned so that they provide even pressure on the media. The toggles are positioned by sliding them to the desired location. On media too narrow to accommodate both toggles, position one toggle over the center of the media and decrease the pressure on the unused toggle. If you are using a 90 or 96XiIII printer, position the single toggle over the center of the media.

NOTE: Make sure that the toggle pressure is even across the width of the media. Otherwise, the media and/or ribbon may “drift.”

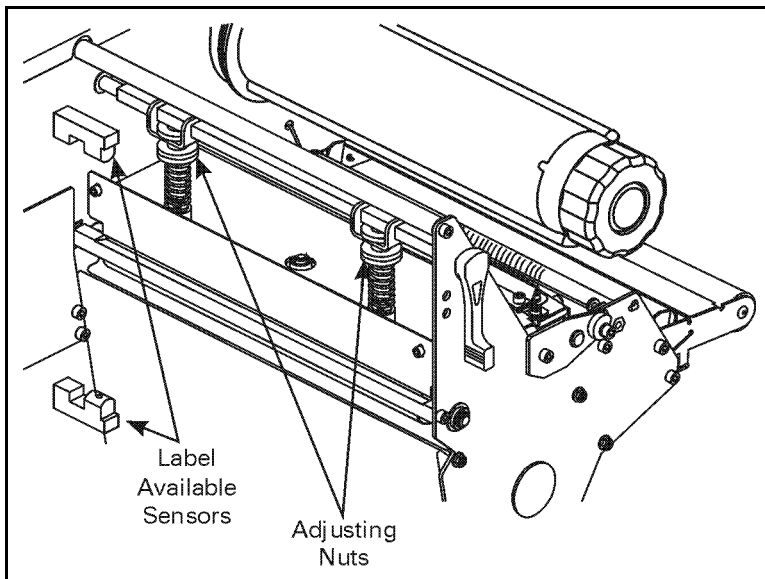

Figure 32

Printhead Pressure Adjustment

This adjustment may be necessary if printing is too light on one side or if thick media is used. Refer to Figure 32.

1. Perform the toggle positioning procedure. If the problem is solved, you may stop here; otherwise, continue with the rest of this procedure.
2. Print some labels at 2.4"/61 mm per second by running the PAUSE Key Self Test (see page 83).
3. While printing labels, lower the darkness setting until a gray level of printing is seen.
4. Loosen the knurled (upper) locking nuts at the top of the toggle assembly/assemblies.
5. Increase or decrease spring pressure using the knurled (lower) adjusting nuts on the shafts of the toggle until the left and right edges of printed area are equally dark.

NOTE: Printhead life can be maximized by using the lowest pressure that produces the desired print quality.

6. Increase darkness to the optimum level for the media being used.
7. Retighten locking nuts.

Media Sensor Position Adjustment

See “Positioning the Media Sensors” on page 10.

Troubleshooting

LED Error Conditions and Warnings

Error Condition Ribbon Out

Problem	Solution
In thermal transfer mode, the ribbon is not loaded <i>or</i> loaded incorrectly.	Load the ribbon correctly. See "Ribbon Loading" on page 38.
In thermal transfer mode, the ribbon sensor is not sensing correctly loaded ribbon.	Perform the media and ribbon sensor calibration (see page 17).
In direct thermal mode, when ribbon is not used:	Put the printer in direct thermal mode via the front panel and remove ribbon (if loaded).
	Ensure that the printer driver or software settings are correctly set (if applicable).

Error Condition Paper Out

Problem	Solution
The media is not loaded <i>or</i> loaded incorrectly.	Reload the media. Refer to "Roll Media Loading" on page 27.
The media sensor is not adjusted properly.	Check the position of the upper and lower media sensors. Refer to "Positioning the Media Sensors" on page 10.
The printer is set for non-continuous media, but continuous media is loaded.	Either load the correct media or set the printer for the correct media type via the front panel.
	Ensure that the printer driver or software settings are correctly set (if applicable).
	Calibrate the printer (see page 17).
The incorrect media sensor is being used.	Via the front panel, check the sensor type to ensure that the correct one is used for the media loaded. See page 16. Calibrate the printer (see page 17).
The maximum label length is set shorter than the label length being used.	Via the front panel, set the label length to a value that is slightly longer than the length of the label being used.

Error Condition Head Open

Problem	Solution
The printhead is not fully closed.	Close the printhead.

Error Condition Head Element Bad

Problem	Solution
One or more of the printhead elements has failed the printhead element test.	If the failed elements impact your printing application, replace the printhead. To override this error, disable the head test count feature on the front panel by defaulting the value to "0000." See page 57.

Warning Ribbon In

Problem	Solution
The ribbon is loaded.	Remove the ribbon and set the printer to direct thermal mode.
	Ensure that the printer driver and/or software settings are correctly set (if applicable).

Warning Head Too Hot

Problem	Solution
The printhead is over temperature.	Allow the printer to cool. Printing automatically resumes when the printhead elements cool to an acceptable operating temperature.

Warning Head Cold

Problem	Solution
The printhead is under temperature.	Continue printing while the printhead reaches the correct operating temperature. If the error remains, the environment may be too cold for proper printing. Relocate the printer to a warmer area.

Warning Cutter Jammed

Problem	Solution
Cutter blade is in the media path.	Turn off the printer power and unplug the printer. Inspect the cutter module for debris and clean as needed following the cleaning instructions on page 71.

Out of Memory*

Problem	Solution
*There is not enough memory to perform the function shown on the second line of the error message.	Insufficient memory for the label length, downloaded fonts/graphics, and images.
	Ensure that the device, such as FLASH memory or PCMCIA card, is installed and not write protected or full.
	Ensure that the data is not directed to a device that is not installed or available.

Print Quality Problems

General Print Quality Issues

Problem	Solution
You are using an incorrect media and ribbon combination for your application.	Consult your authorized Zebra reseller/distributor for information and advice.
The printer is set at the incorrect print speed.	For optimal print quality, set the print speed to the lowest possible setting via ZPL II, the driver, or the software.
The printer is set at the incorrect darkness level.	For optimal print quality, set the darkness to the lowest possible setting via the front panel, the driver, or the software.
The printhead is dirty.	Clean the printhead according to the instructions on page 64.
There is light printing (or no printing) on the left or right side of the label or the printed image is not sharp.	The toggle pressure needs to be adjusted. Follow the printhead pressure adjustment instructions on page 74.

Gray lines on blank labels with no consistent pattern

Problem	Solution
The printhead is dirty.	Clean the printhead according to the instructions on page 64.

Light, consistent vertical lines running through all of the labels

Problem	Solution
The printhead or platen roller is dirty.	Clean the printhead, platen roller, or both according to the instructions on page 64.

Intermittent creases on the left and right edges of the labels

Problem	Solution
There is too much toggle pressure on the printhead.	Reduce the toggle pressure. See "Printhead Pressure Adjustment" on page 74.

A label format was sent to the printer. Several labels print, then the printer skips, misplaces, misses, or distorts the image on the label.

Problem	Solution
The host is set to EPP parallel communications.	Change the settings on the computer host to standard parallel communications.
The serial communication settings are incorrect.	Ensure that the flow control settings match.
	Check the communication cable length. See page 22 for requirements.
	Check the printer driver or software communications settings (if applicable).

A label format was sent to the printer but not recognized. The DATA light flashes but no printing occurs.

Problem	Solution
The prefix and delimiter characters set in the printer do not match the ones in the label format.	Verify the prefix and delimiter characters. See page 54.
Incorrect data is being sent to the printer.	Ensure that ZPL is being used.
	Check the communication settings on the computer. Ensure that they match the printer settings.

The printer fails to calibrate or detect the top of the label.

Problem	Solution
The printer was not calibrated for the label being used.	Perform the calibration procedure on page 17.
The printer is configured for continuous media.	Set the media type to non-continuous media.
The driver or software configuration is not set correctly.	As driver or software settings produce ZPL commands that can overwrite the printer configuration, check the driver or software media-related setting.

Printer Diagnostics

Power-On Self Test

A limited Power-On Self Test (POST) is performed automatically each time the printer is turned on (additional self tests can be performed by pressing the CANCEL and CALIBRATE keys when you turn the printer on). During either test sequence, the front panel lights and liquid crystal display (LCD) monitor the progress of the POST. If the printer fails any of these tests, the word “FAILED” is added to the display. If this occurs, notify an authorized Zebra reseller.

Additional Printer Self Tests

These self tests produce sample printouts and provide specific information that help determine the operating conditions for the printer.

Each self test is enabled by pressing a specific front panel key or combination of keys while turning the POWER switch on. Keep the key(s) depressed until the DATA light turns off. When the power-on self test is complete, the selected self test starts automatically.

NOTE: When performing self tests, avoid sending a label format to the printer. In the case of a remote host, disconnect all data interface cables from the printer.

When canceling a self test prior to its actual completion, always turn the printer power off and then back on to reset the printer.

When performing these self tests while in the peel-off mode, you must remove the labels as they become available.

If your media is not wide enough or long enough, unexpected and/or undesired results may occur. Make sure that your print width is set correctly for the media you are using before you run any self tests, otherwise the test may print out on the platen roller.

CANCEL Key Self Test

This self test prints a listing of the configuration parameters currently stored in the printer's memory. See Figure 33 (depending on the options ordered, your label may look different).

1. Turn the printer off.
2. Press and hold the CANCEL key while turning on the power.

The configuration may be changed either temporarily (for specific label formats or ribbon and label stock) or permanently (by saving the new parameters in memory). Saving new parameters occurs whenever a calibration procedure is performed. Refer to page 15 for further information about the configuration procedure. Additional Power-Up Self Tests are also performed during the POST for this test.

PRINTER CONFIGURATION	
Zebra Technologies ZTC 140XiIII-200dpi	
+10.....	DARKNESS
+000.....	TEAR OFF
TEAR OFF.....	PRINT MODE
NON-CONTINUOUS.....	MEDIA TYPE
WEB.....	SENSOR TYPE
THERMAL-TRANS.....	PRINT METHOD
128 0/8 MM.....	PRINT WIDTH
1722.....	LABEL LENGTH
39.0IN 988MM.....	MAXIMUM LENGTH
PARALLEL.....	PARALLEL COMM.
RS232.....	SERIAL COMM.
19200.....	BAUD
8 BITS.....	DATA BITS
NONE.....	PARITY
2 STOP BITS.....	STOP BITS
XON/XOFF.....	HOST HANDSHAKE
NONE.....	PROTOCOL
000.....	NETWORK ID
NORMAL MODE.....	COMMUNICATIONS
< > 7EH.....	CONTROL PREFIX
<^> 5EH.....	FORMAT PREFIX
<,> 2CH.....	DELIMITER CHAR
ZPL II.....	ZPL MODE
FEED.....	MEDIA POWER UP
FEED.....	HEAD CLOSE
DEFAULT.....	BACKFEED
+010.....	LABEL TOP
+0000.....	LEFT POSITION
0000.....	HEAD TEST COUNT
0500.....	HEAD RESISTOR
OFF.....	VERIFIER PORT
OFF.....	APPLICATOR PORT
057.....	WEB S.
075.....	MEDIA S.
064.....	RIBBON S.
092.....	MARK S.
092.....	MARK MED S.
013.....	MEDIA LED
046.....	RIBBON LED
000.....	MARK LED
+10.....	LCD ADJUST
DPSWFXM.....	MODES ENABLED
1024 8/MM FULL.....	MODES DISABLED
.....	RESOLUTION
.....	SOCKET 1 ID
V33.10.0 <.....	FIRMWARE
.....	HARDWARE ID
CUSTOMIZED.....	CONFIGURATION
12288.....	R: RAM
4096.....	B: MEMORY CARD
2048.....	E: ONBOARD FLASH
NONE.....	FORMAT CONVERT
007 POWER SUPPLY.....	J12 INTERFACE
*** CUTTER.....	J11 INTERFACE
005 DISPLAY.....	J9 INTERFACE
*** NONE.....	J8 INTERFACE
*** NONE.....	J7 INTERFACE
.....	TWINAX/COAX ID
NONE.....	ZEBRA NET II

FIRMWARE IN THIS PRINTER IS COPYRIGHTED

Figure 33

PAUSE Key Self Test

This self test can be used to provide the test labels required when making adjustments to the printer's mechanical assemblies. See the sample printout in Figure 34.

1. Turn off the printer.
2. Press and hold the PAUSE key while turning on the power.
 - The initial self test prints 15 labels at 2.4"/61 mm per second (1"/25.4 mm per second for the 96XiIII), then automatically pauses the printer. When the PAUSE key is pressed, an additional 15 labels print.
 - While the printer is paused, pressing the CANCEL key alters the self test. When the PAUSE key is pressed, the printer prints 15 labels at 6"/152 mm per second (4"/102 mm per second for the 96XiIII).
 - While the printer is paused, pressing the CANCEL key again alters the self test again. When the PAUSE key is pressed, the printer prints 50 labels at 2.4"/61 mm per second (1"/25.4 mm per second for the 96XiIII).
 - While the printer is paused, pressing the CANCEL key again alters the self test a third time. When the PAUSE key is pressed, the printer prints 50 labels at 6"/152 mm per second (4"/102 mm per second for the 96XiIII).
 - While the printer is paused, pressing the CANCEL key again alters the self test a fourth time. When the PAUSE key is pressed, the printer prints 15 labels at the printer's maximum speed.
 - To exit this self test at any time, press and hold the CANCEL key.

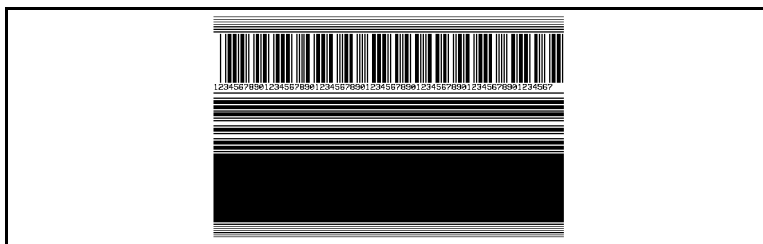

Figure 34

FEED Key Self Test

See Figure 35.

1. Turn off the printer.
2. Press and hold the FEED key while turning on the power.

The FEED key self test prints out at various darkness settings above and below that of the darkness value shown on the configuration label. Look at these labels and determine which one has the best darkness setting for your application. This value can be entered into the printer by setting the darkness during the configuration procedure. Refer to page 44 for more information.



Figure 35

The value printed on that label is added to (plus) or subtracted from (minus) the darkness value specified on the configuration label. The resulting numeric value (0 to 30) is the best darkness value for that specific media/ribbon combination.

FEED Key and PAUSE Key Self Test

1. Turn off the printer.
2. Press and hold the FEED and PAUSE keys while turning on the power.

Performing this self test temporarily resets the printer configuration to the factory default values. These values are active only until power is turned off unless you save them permanently in memory.

Communications Diagnostics Test

This test is controlled from the front panel display. Refer to “COMMUNICATIONS” on page 53. A typical printout from this test is shown in Figure 36. Turn off the power to exit this self test.

NOTE: This label is inverted when printed.

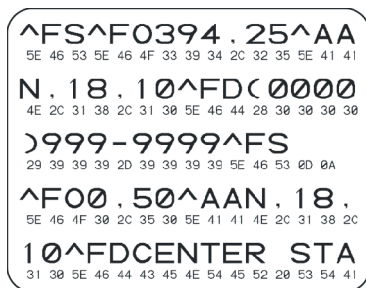

Figure 36

Additional Printer Diagnostics

Additional diagnostic tests are available for this printer, however, they are beyond the scope of this user’s guide. Refer to the maintenance manual for information about these additional tests.



Specifications

NOTE: Printer specifications are subject to change without notice.

Media Handling

- **Tear-off** mode: Labels are produced in strips.
- **Peel-off** mode: Labels are dispensed and peeled from the liner as needed.
- **Cutter** mode: Labels are printed and individually cut.
- **Rewind** mode: Labels are rewound internally.

Options

• Cutter	• IBM twinax interface
• Rewind	• IBM coax interface
• Cutter-rewind	• RS-485 interface
• Cutter tray	• Font cards
• Media supply spindle (1.6"/40 mm core)	• DRAM memory expandable to 12 MB
• Media supply spindle (3"/76 mm core)	• Memory cards
• Applicator interface	• Printer drivers for Windows™ operating systems
• Real time clock	• Double-hinged media door with clear panel
• Bar-One® Windows™-based WYSIWYG on-screen label design and print application software	• ZebraNet® PrintServer II, including Ethernet interface (10Base-T), ZebraLink™ WebView graphical setup and printer control, and ZebraLink™ Alert unsolicited error notification
• Advanced counter	

Zebra Programming Language (ZPL II®)

• Downloadable graphics, scalable and bitmap fonts, and label formats	• Controlled via mainframe, mini-computer, PC, portable data terminal
• Object copying between memory areas (RAM, memory card, and internal FLASH)	• Programmable quantity with print, pause, and cut control
• Code Page 850 character set	• Communicates in printable ASCII characters
• Adjustable print cache	• Error-checking protocol
• Data compression	• Status message to host upon request
• Automatic virtual input buffer management	• Serialized fields
• Format inversion	• In-spec OCR-A and OCR-B
• Mirror image printing	• UPC/EAN
• Four-position field rotation (0°, 90°, 180°, 270°)	• User-programmable password
• Slew command	

Bar Codes

• Bar code ratios - 2:1, 7:3, 5:2, 3:1	• ISBT-128
• Codabar (supports ratios of 2:1 up to 3:1)	• LOGMARS
• CODABLOCK	• MaxiCode
• Code 11	• Micro PDF
• Code 39 (supports ratios of 2:1 up to 3:1)	• MSI
• Code 49 (2-dimensional bar code)	• PDF-417 (2-dimensional bar code)
• Code 93	• Plessey
• Check digit calculation where applicable	• POSTNET
• Data Matrix	• QR-Code
• EAN-8, EAN-13, EAN extensions	• Standard 2 of 5
• Industrial 2 of 5	• UPC-A, UPC-E, UPC extensions
• Interleaved 2 of 5 (supports ratios of 2:1, up to 3:1, Modulus 10 Check Digit)	• Code 128 (with subsets A, B, and C and UCC case C codes)

General Specifications

General Specifications			90/96XiIII		140XiIII		170XiIII		220XiIII		
Height			15.5"	393.7 mm	15.5"	393.7 mm	15.5"	393.7 mm	15.5"	393.7 mm	
Width			9.15"	232.4 mm	11.15"	283.2 mm	13.15"	334.4 mm	15.65"	397.5 mm	
Depth			19.5"	495.3 mm	19.5"	495.3 mm	19.5"	495.3 mm	19.5"	495.3 mm	
Weight (without options)			50 lb	22.7 kg	55 lb	25 kg	67 lb	30.5 kg	72 lb	32.7 kg	
Electrical	General (auto adjusting)		90-264 VAC; 48-62 Hz		90-264 VAC; 48-62 Hz		90-264 VAC; 48- 62 Hz		90-264 VAC; 48-62 Hz		
	Power Consumption	Printing PAUSE test label at slowest speed	121 W		180 W		220 W		269 W		
		Printer idle	20 W		19 W		19 W		20 W		
	Compliance		Complies with FCC class "B" and Canadian Doc. class "A" rules. Carries the CE mark of compliance.								
Temperature	Operating environment	Thermal transfer	41° to 104° F	5° to 40° C	41° to 104° F	5° to 40° C	41° to 104° F	5° to 40° C	41° to 104° F	5° to 40° C	
		Direct thermal	32° to 104° F	0° to 40° C	32° to 104° F	0° to 40° C	32° to 104° F	0° to 40° C	32° to 104° F	0° to 40° C	
	Storage		-40° to 140°F	-40° to 60° C	-40° to 140°F	-40° to 60° C	-40° to 140°F	-40° to 60° C	-40° to 140°F	-40° to 60° C	
Relative Humidity	Operating Environment		20% to 85% non-condensing								
	Storage		5% to 85% non-condensing								

Printing Specifications

Printing Specifications			90XIII	96XIII	140XIII	170XIII	220XIII
Resolution			300 dots/inch (12 dots/mm)	600 dots/inch (23.5 dots/mm)	203 dots/inch (8 dots/mm)	300 dots/inch (12 dots/mm)	203 dots/inch (8 dots/mm)
Dot size (width x length)			0.0033" x 0.0039" (0.84 mm x 0.100 mm)	0.0016" x 0.0016" (0.042 mm x 0.042 mm)	0.0049" x 0.0049" (0.125 mm x 0.125 mm)	0.0033" x 0.0039" (0.84 mm x 0.100 mm)	0.0049" x 0.0049" (0.125 mm x 0.125 mm)
First dot location measured from inside media edge			0.12" ± 0.035" (3 mm ± 0.89 mm)	0.12" ± 0.035" (3 mm ± 0.89 mm)	0.10" ± 0.035" (2.5 mm ± 0.89 mm)	0.10" ± 0.035" (2.5 mm ± 0.89 mm)	0.10" ± 0.035" (2.5 mm ± 0.89 mm)
Maximum print width			3.4" (86 mm)	3.2" (81 mm)	5.04" (128 mm)	6.6" (168 mm)	8.5" (216 mm)
Print length (maximum)	Non-continuous printing	With standard memory	39" (991 mm)	20" (508 mm)	39" (991 mm)	39" (991 mm)	39" (991 mm)
		With 12 MB memory	39" (991 mm)	39" (991 mm)	39" (991 mm)	39" (991 mm)	39" (991 mm)
	Continuous printing	With standard memory	80" (2032 mm)	20" (508 mm)	121" (3073 mm)	41" (1041 mm)	71" (1803 mm)
		With 12 MB memory	100" (2540 mm)	52" (1321 mm)	150" (3810 mm)	100" (2540 mm)	150" (3810 mm)
Bar code modulus ("X") dimension	Ladder (rotated) orientation	3.9 mil to 39 mil	1.6 mil to 16 mil	4.9 mil to 49 mil	3.9 mil to 39 mil	4.9 mil to 49 mil	
	Picket fence (non-rotated) orientation	3.33 mil to 33 mil	1.6 mil to 16 mil	4.9 mil to 49 mil	3.33 mil to 33 mil	4.9 mil to 49 mil	
Thin film printhead with Element Energy Equalizer (E3) [®]			Yes	Yes	Yes	Yes	Yes

Ribbon Specifications

Ribbon Specifications			90/96XIII	140XIII	170XIII	220XIII	
Ribbon must be wound with the coated side out.							
Ribbon width (Zebra recommends using ribbon at least as wide as the media to protect the printhead from wear.)			Minimum	0.79" (20 mm)	1.57" (40 mm)	2.0" 51 mm)	4.25" (108 mm)
			Maximum	3.40" (87 mm)	5.10" (130 mm)	6.7" 170 mm)	8.60" (220 mm)
Standard lengths	2:1 media to ribbon roll ratio		984 ft. (300 m)	984 ft. (300 m)	984 ft. (300 m)	984 ft. (300 m)	
	3:1 media to ribbon roll ratio		1476 ft. (450 m)	1476 ft. (450 m)	1476 ft. (450 m)	1476 ft. (450 m)	
Ribbon core inside diameter			1.0" (25.4 mm)	1.0" (25.4 mm)	1.0" (25.4 mm)	1.0" (25.4 mm)	
Maximum ribbon roll outside diameter			3.2" (81.3 mm)	3.2" (81.3 mm)	3.2" (81.3 mm)	3.2" (81.3 mm)	

Media Specifications

Media Specifications		90/96XIII	140XIII	170XIII	220XIII	
Minimum label length*	Tear-off	0.7" (18 mm)	0.7" (18 mm)	0.7" (18 mm)	0.7" (18 mm)	
	Peel-off	0.5" (13 mm)	0.5" (13 mm)	0.5" (13 mm)	0.5" (13 mm)	
	Cutter	1.5" (38 mm)	1.5" (38 mm)	1.5" (38 mm)	1.5" (38 mm)	
	Rewind	0.25" (6 mm)	0.25" (6 mm)	0.25" (6 mm)	0.25" (6 mm)	
Total media width (label + liner, if any)	Minimum	0.79" (20 mm)	1.57" (40 mm)	2.00" (51 mm)	4.25" (108 mm)	
	Maximum	3.54 mm (90 mm)	5.51 mm (140 mm)	7.1 mm (180 mm)	8.80 mm (224 mm)	
Total thickness (includes liner, if any)	Minimum	0.003" (0.076 mm)	0.003" (0.076 mm)	0.003" (0.076 mm)	0.003" (0.076 mm)	
	Maximum	0.012" (0.305 mm)	0.012" (0.305 mm)	0.012" (0.305 mm)	0.012" (0.305 mm)	
Cutter maximum full-width media thickness		0.014" (0.35 mm)	0.009" (0.23 mm)	0.007" (0.18 mm)	0.005" (0.14 mm)	
Roll media core inside diameter		3" (76 mm)	3" (76 mm)	3" (76 mm)	3" (76 mm)	
Maximum roll diameter		8.0" (203 mm)	8.0" (203 mm)	8.0" (203 mm)	8.0" (203 mm)	
Inter-label gap	Minimum	0.079" (2 mm)	0.079" (2 mm)	0.079" (2 mm)	0.079" (2 mm)	
	Preferred	0.118" (3 mm)	0.118" (3 mm)	0.118" (3 mm)	0.118" (3 mm)	
	Maximum	Maximum inter-label gap = 2 x (label length for which you have calibrated the printer) + 1"				
Maximum internal fanfold media pack size (label + liner) L x W x H		8.0" x 4.5" x 4.5" (203 mm x 114 mm x 114 mm)	8.0" x 5.5" x 4.5" (203 mm x 140 mm x 114 mm)	8.0" x 7.1" x 4.5" (203 mm x 180 mm x 114 mm)	8.0" x 8.8" x 4.5" (203 mm x 224 mm x 114 mm)	
Ticket/tag sensing notch L x W		0.12" x 0.25" (3 mm) x (6 mm)	0.12" x 0.25" (3 mm) x (6 mm)	0.12" x 0.25" (3 mm) x (6 mm)	0.12" x 0.25" (3 mm) x (6 mm)	
Ticket/tag sensing hole diameter		0.125" (3 mm)	0.125" (3 mm)	0.125" (3 mm)	0.125" (3 mm)	
Effective leading edge registration accuracy*	Vertical	± 0.060" (±1.5 mm)	± 0.070" (±1.8 mm)	± 0.060" (±1.5 mm)	± 0.050" (±1.3 mm)	
	Horizontal	± 0.060" (±1.5 mm)	± 0.070" (±1.8 mm)	± 0.060" (±1.5 mm)	± 0.060" (±1.5 mm)	
Additional specifications for black mark sensing	Mark length (measuring parallel to label/tag edge)	Minimum	0.12" (3 mm)	0.12" (3 mm)	0.12" (3 mm)	0.12" (3 mm)
		Maximum	0.43" (11 mm)	0.43" (11 mm)	0.43" (11 mm)	0.43" (11 mm)
	Mark width (measuring to perpendicular label/tag edge)	Minimum	0.43" (11 mm)	0.43" (11 mm)	0.43" (11 mm)	0.43" (11 mm)
		Maximum	Full media width	Full media width	Full media width	Full media width
	Mark location	Marks must be located within 0.040" (1 mm) of the inside media edge.				
	Mark density	>1.0 Optical Density Unit (ODU)	>1.0 Optical Density Unit (ODU)	>1.0 Optical Density Unit (ODU)	>1.0 Optical Density Unit (ODU)	
Maximum density of the back of the media on which the black mark is printed	0.5 ODU	0.5 ODU	0.5 ODU	0.5 ODU		

* Media registration and minimum label length are affected by media type and width, ribbon type, print speed, and printer mode of operation. Performance improves as these factors are optimized. Zebra recommends always qualifying any application with thorough testing.

Power Line Cord Specifications

- The overall length must be less than 9.8 feet (3.0 meters).
- It must be rated for at least 5 A, 250 V.
- The chassis ground (earth) **MUST** be connected to ensure safety and reduce electromagnetic interference. The ground connection is handled by the third wire (earth) in the power line cord. See Figure 37.
- The AC power plug and IEC 320 connector must bear the certification mark of at least one of the known international safety organizations shown in Figure 38.

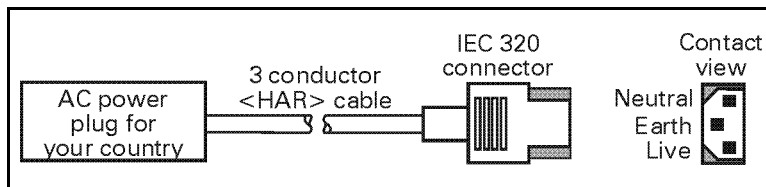

Figure 37

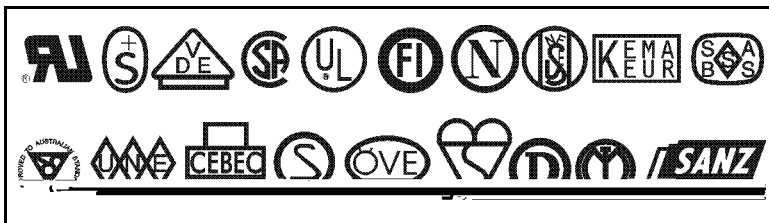

Figure 38

Printer Interface Technical Information

RS-232/RS-422/RS-485 Serial Data Port

The connections for these standard interfaces are made through the DB-25S connector on the rear panel. For all RS-232 input and output signals, the printer follows both the Electronics Industries Association's (EIA) RS-232 specifications and the Consultative Committee for International Telegraph and Telephone (CCITT) V.24 standard signal level specifications.

The following table shows the pin configuration and function of the rear panel serial data connector on the printer.

Pin No.	Description
1	FG (frame ground) for cable shield
2	TXD (RS-232 transmit data) output from printer
3	RXD (RS-232 receive data) input to printer
4	RTS (RS-232 request to send) output from printer
6	DSR (data set ready) input to printer
7	SG (signal ground) for RS-232
9	+5 VDC source output (1 Amp maximum)
11	SGR (signal ground reference) for RS-422/RS-485
13	Data input B(-); RS-422/RS-485
14	Data output B(-); RS-422/RS-485
16	Data input A(+); RS-422/RS-485
19	Data output A(+); RS-422/RS-485
20	DTR (RS-232 data terminal ready) output from printer
	NOTE: Pins 5, 8, 10, 12, 15, 17-18, 21-25 are unused and unterminated.

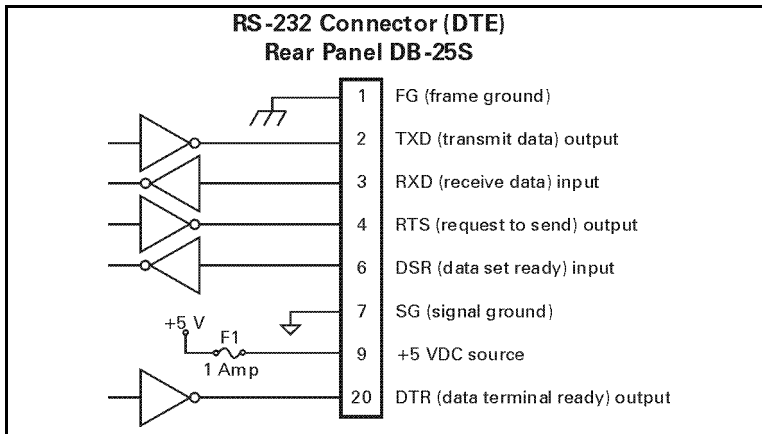

Figure 39

RS-232 Interconnections

The printer is configured as Data Terminal Equipment (DTE). Figure 39 illustrates the internal connections of the printer's RS-232 connector.

Figure 40 illustrates the connections required to interconnect the printer with the standard 9-pin serial port connector on a computer.

NOTE: If using a 9-pin to 25-pin adapter plug attached to the computer, use a null modem cable between the adapter plug and the printer.

To connect the printer to other DTE devices with DB-25 connectors (such as the serial port of a PC), an RS-232 null modem (crossover) cable should be used.

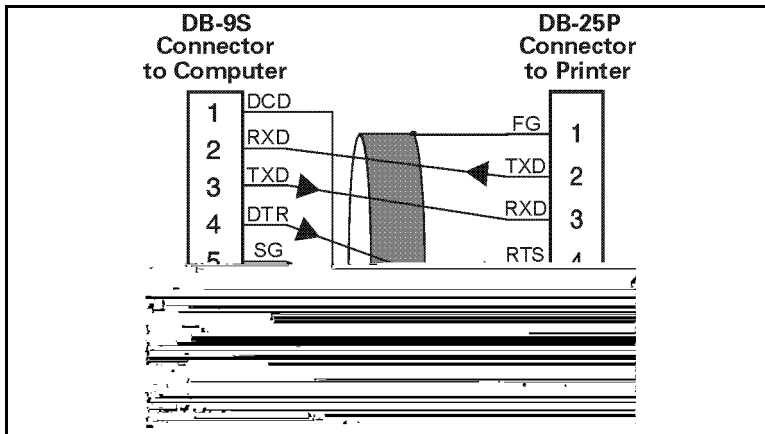

Figure 40

When the printer is connected via its RS-232 interface to Data Communication Equipment (DCE) such as a modem, use a standard RS-232 (straight-through) interface cable. Figure 41 illustrates the connections required for this cable.

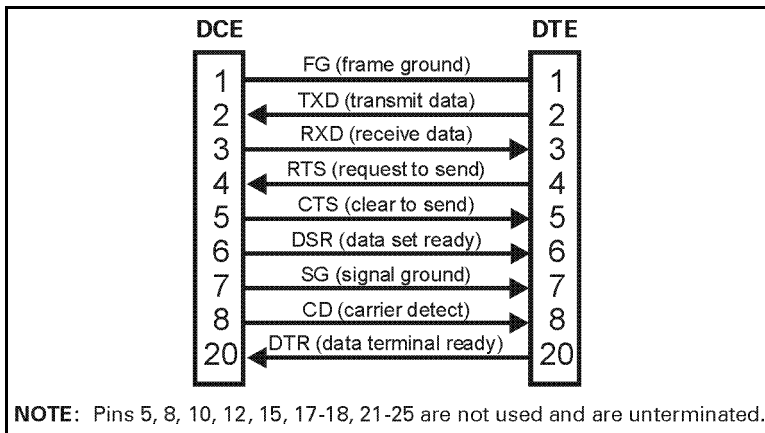

Figure 41

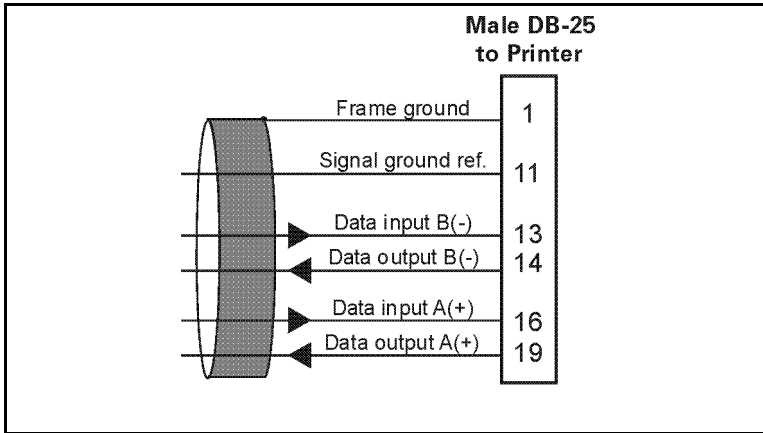

Figure 42

RS-422/RS-485 Interconnections

The printer may be connected to a host computer by either an RS-422 or an RS-485 interface. The DB-25 connector on the rear of the printer uses specific pins for this purpose. Figure 42 illustrates the required cable wiring for interconnecting to the printer's DB-25 connector. Figure 43 illustrates the internal connections of the printer's RS-422 or RS-485 connector.

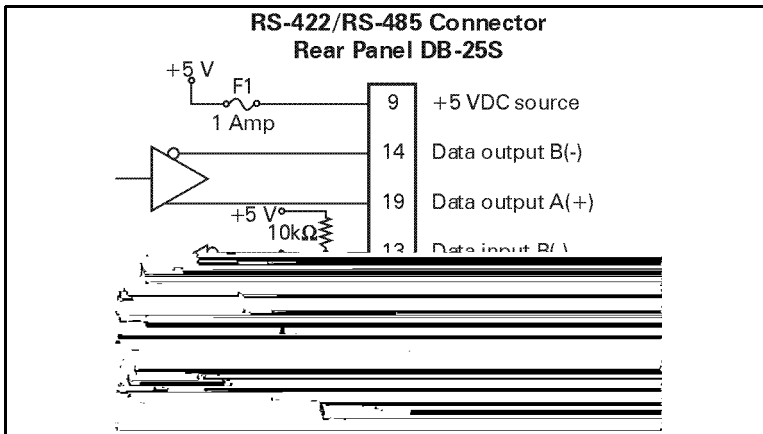

Figure 43

Parallel Data Port

A standard 36-pin parallel connector is available at the rear of the printer for connection to the data source. Under normal circumstances, data sent from the printer to the host computer in response to a “Printer Status Request” command is sent through the RS-232 serial port. However, if the host computer has a properly configured IEEE-1284 parallel port that is recognized by the printer, status information is returned through the parallel port. Port selection for status information is determined each time the printer is turned on.

Parallel Port Interconnections

The following table shows the pin configuration and function of a standard computer-to-printer parallel cable.

36-pin Connector	Description
1	nStrobe/HostClk
2-9	Data Bits 1-8
10	nACK/PtrClk
11	Busy/PtrBusy
12	PError/ACKDataReq
13	Select/Xflag
14	nAutoFd/HostBusy
15	Not used
16 & 17	Ground
18	+5V @ 1A
19-30	Ground
31	ninit
32	nFault/NDataAvail
33 & 34	Not used
35	+5V through a 4.7 KW Resistor
36	NSelectin/1284 active



Index

A

Adjustments

- Lower Media Sensor, 12
- Media Sensor Position, 74
- Printhead Pressure, 74
- Toggle Positioning, 73
- Upper Media Sensor, 11

B

Bar Codes, 88

Black Mark Media Sensor, 12

C

Cabling Requirements, 22

Calibration, 5–20

CANCEL Key Self Test, 82

Cleaning

- Cutter Module, 71
- Exterior, 64
- Interior, 64
- Printhead and Platen Roller, 64
- Sensors, 69
- Snap Plate, 69

Cleaning Schedule, 63

Communications Diagnostics Test, 85

Configuration

- Calibration Sequence, 44–62
- Changing Password-Protected Parameters, 42
- Entering the Setup Mode, 41
- Leaving the Setup Mode, 43
- Printer, 15
- Software or Printer Driver, 16

Continuous Media, 7

D

Damage, 2

Data Specifications, 21

F

Fanfold Media Loading, 35

FEED Key and PAUSE Key Self Test, 85

FEED Key Self Test, 84

Front Panel Display, 24

Front Panel Keys, 25

Front Panel Lights, 26

Fuse Replacement, 71

I

Interfaces, 21

IP Network Configuration, 41

L

Label Backing Material Removal, 37

LED Error Conditions and Warnings, 75

Loading the Media, 9, 27

Lubrication, 71

M

Media and Ribbon Calibration, 17

Media and Ribbon Requirements, 3

Media Handling, 87

Media Loading (See Roll Media Loading)

Media Sensors Positioning

Black Mark Sensor, 12

Transmissive Sensor, 10

Media Specifications, 91

Media Types

Continuous Media, 7

Non-Continuous Black Mark Media, 7

Non-Continuous Web Media, 6

N

Non-continuous Black Mark Media, 7

Non-Continuous Web Media, 6

O

Operator Controls

- Front Panel Display, 24
- Front Panel Keys, 25
- Front Panel Lights, 26
- Front Panel, 14
- POWER Switch, 14, 23

Options, 87

P

Passwords (See Configuration)

Power Cord, 3

Power Line Cord, 92

POWER Switch, 23

Print Mode

- Cutter, 8
- Peel-Off, 8
- Rewind, 8
- Tear-Off, 8

Print Quality Problems, 78

Printer Anatomy Overview, 4

Printer Diagnostics, 81

Printer Driver Configuration, 16

Printer Interface Technical Information

- Parallel Data Port, 97
- RS-232 Interconnections, 94
- RS-232/RS-422/RS-485 Serial Data Port, 93
- RS-422/RS-485 Interconnections, 96

Printing Specifications, 90

R

Ribbon Loading, 13, 38

Ribbon Removal, 40

Ribbon Requirements, 3

Ribbon Specifications, 90

Roll Media Loading

- Cutter Mode, 32
- Peel-Off Mode, 28
- Rewind Mode, 30, 33
- Tear-Off Mode, 27

S

Self Tests

- Additional Printer Self Tests, 81
- CANCEL Key, 82
- Communications Diagnostics Test, 85
- FEED Key and PAUSE Key, 85
- FEED Key, 84
- PAUSE Key, 83
- Power-on, 81

Serial Data Port, 93

Software Configuration, 16

Specifications

- Bar Codes, 88
- General, 89
- Media Handling, 87
- Media, 91
- Options, 87
- Power Line Cord, 92
- Printing, 90
- Ribbon, 90
- ZPL Programming Language, 88

Storage, 2

System Considerations

- Data Specifications, 21
- Interfaces, 21

T

Test Label Printing, 19

Transmissive Media Sensor, 10

Troubleshooting

- Communications, 79
- LED Error Conditions and Warnings, 75
- Print Quality Problems, 78
- Wrinkled Ribbon, 79

U

Unpacking and Inspection, 2

Upper Media Sensor Adjustment, 11

W

Wrinkled Ribbon, 79

Z

ZPL Programming Language, 88

To qualify for this warranty, the printhead must be returned to the factory or to an authorized service center. Customers are not required to purchase Zebra supplies (media and/or ribbons) for warranty qualification.

However, if it is determined that the use of other manufacturer supplies has caused any defect in the printhead for which a warranty claim is made, the user is responsible for Zebra's labor and material charges required to repair the defect. The warranty becomes void if the printhead is physically worn or damaged; also if it is determined that failure to follow the preventive maintenance schedule listed in the user's guide has caused defect in the thermal printhead for which a warranty claim is made.

Software. Software is warranted to be free of defects in material and workmanship for 30 days from the date of purchase. In the event of notification within the warranty period of defects, Zebra will replace the defective diskette or documentation.

Batteries. Mobile printer batteries are warranted to be free of defects in material and workmanship for 90 days from date of purchase. In the event of notification within the warranty period, Zebra will replace the defective battery provided there has not been damage resulting from user abuse.

Supplies Products

Supplies are warranted to be free from defect in material and workmanship for a period of six (6) months for media and twelve (12) months for ribbon from the date of shipment by Zebra. This is provided the user has complied with storage guidelines, handling, and usage of the supplies in Zebra printers.

Zebra's sole obligation under these warranties is to furnish parts and labor for the repair or possible replacement of products found to be defective in material or workmanship during the warranty period. Zebra may in its discretion issue a credit for any such defective products in such amount as it deems reasonable.

Warranty Exclusions & Conditions Statement

The warranties provided above are the only warranties applicable. No other warranties, expressed or implied, are given. Zebra does not make any IMPLIED WARRANTY OF MERCHANTABILITY OR FITNESS FOR A PARTICULAR PURPOSE in connection with its sale of products or services. While Zebra's desire is to be responsive to specific needs and questions, Zebra does not assume responsibility for any specific application to which any products are applied including, but not limited to, compatibility with other equipment. All statements, technical information or recommendations relating to Zebra products are based upon tests believed to be reliable yet do not constitute a guaranty or warranty.

Zebra's maximum liability for warranty claims is limited to the invoice price of the product claimed defective. Zebra does not assume responsibility for delays or replacement or repair of products. Zebra shall not under any circumstances whatsoever be liable to any party for loss of profits, lost data, diminution of good will, or any other special or consequential damages whatsoever with respect to any claim made under agreement with Zebra. Specifically for software, Zebra is not liable for any incidental or consequential damages caused by abuse or misapplication of the software or by its use in violation of the U.S. copyright law or international treaty.

No salesperson, representative, or agent of Zebra is authorized to make any guaranty, warranty, or representation that contradicts the foregoing. Any waiver, alteration, addition or modification to the foregoing warranties must be in writing and signed by an executive officer of Zebra to be valid.





Printer Software and Firmware License Agreement

YOU SHOULD CAREFULLY READ THE FOLLOWING TERMS AND CONDITIONS OF THIS ZEBRA TECHNOLOGIES CORPORATION PRINTER SOFTWARE AND FIRMWARE LICENSE AGREEMENT ("PSFLA") BEFORE USING THE PRINTER WHICH IS ENCLOSED OR OTHERWISE ASSOCIATED WITH THIS AGREEMENT. IF YOU DO NOT AGREE WITH THESE TERMS AND CONDITIONS, DO NOT OPERATE THE PRINTER AND PLEASE PROMPTLY RETURN THE PRINTER, ENCLOSURES AND ALL PACKAGING FOR A FULL REFUND.

Zebra Technologies Corporation ("ZEBRA") hereby grants you a non-exclusive, non-transferable license to use the SOFTWARE and FIRMWARE embedded in the printer and the accompanying documentation according to the following terms:

1. The printer enclosed with or otherwise associated with this Agreement has or includes certain SOFTWARE and FIRMWARE therein which is protected by copyright laws and international copyright treaties, as well as other intellectual property laws and treaties. The SOFTWARE and FIRMWARE is licensed, not sold. Such SOFTWARE and/or FIRMWARE may include, but is not limited to, SOFTWARE and/or FIRMWARE that is licensed under one or more of the following trademarks: ZPL (Zebra Programming Language), ZebraLink, Web View, Web Alert, ZBI (Zebra Basic Interpreter), BarOne, ZTools, Utilities, ZebraNet View for IP, ZebraNet Alert, PC Management Program, ZebraNet View for Networks and ZebraNet Connect.
2. GRANT OF LICENSE. This License grants you the following rights:
 - SOFTWARE and FIRMWARE. You may use, access, display, run, or otherwise interact with ("RUN") the SOFTWARE and FIRMWARE in connection with operating the printer which is enclosed with or otherwise associated with this PSFLA ("PRINTER"). The primary user of the PRINTER may make a second copy for his or her exclusive use on a portable computer/printer.
 - Storage/Network Use. You may also store or install a copy of the SOFTWARE and FIRMWARE on a storage device, such as a network server, used only to RUN the SOFTWARE and FIRMWARE on your other PRINTERS over an internal network; however, you must acquire and dedicate a license for each separate PRINTER on which the SOFTWARE and FIRMWARE is RUN from the storage device. A license for the SOFTWARE and FIRMWARE may not be shared or used concurrently on different PRINTERS.
 - Reservation of Rights. All rights not expressly granted are reserved by ZEBRA.
 - Accessing Services Using the SOFTWARE and FIRMWARE. Your use of any service accessible using the SOFTWARE and FIRMWARE is not covered by this PSFLA and may be governed by separate terms of use, conditions or notices.
3. RESTRICTIONS.
 - You must maintain all copyright notices on all copies of the SOFTWARE and FIRMWARE.
 - Limitations on modification. You may not modify, adapt, translate, or create derivative works based on this SOFTWARE OR FIRMWARE or the accompanying documentation.
 - Limitations of Reverse Engineering, Decompilation and Disassembly. You may not reverse engineer, decompile, or disassemble the SOFTWARE or the FIRMWARE, except and only to the extent that such activity is permitted by applicable law notwithstanding this limitation.

- Rental. You may not rent or lease or lend the SOFTWARE or FIRMWARE.
 - Support Services. ZEBRA may provide you with support services related to the SOFTWARE and/or FIRMWARE ("SUPPORT SERVICES"), in its discretion. Use of SUPPORT SERVICES, if any, is governed by the ZEBRA policies and programs described in the user manual, in "online" documentation, and/or other ZEBRA provided materials. Any supplemental SOFTWARE or FIRMWARE code provided to you as a part of SUPPORT SERVICES shall be considered part of the SOFTWARE and/or FIRMWARE and is subject to the terms of this PSFLA. With respect to technical information you provide to ZEBRA as part of the SUPPORT SERVICES, ZEBRA may use such information for its business purposes, including for product support and development. ZEBRA will not utilize such technical information in a form that personally identifies you except to the extent necessary to provide you with support.
 - Replacement, Modification and Upgrade of the SOFTWARE and/or FIRMWARE. ZEBRA reserves the right to replace, modify or upgrade the SOFTWARE and/or FIRMWARE at any time by offering you a replacement or modified version of the SOFTWARE and/or FIRMWARE or such upgrade and to charge for such replacement, modification or upgrade. Any such replacement or modified SOFTWARE and/or FIRMWARE code or upgrade to the SOFTWARE and/or FIRMWARE offered to you by ZEBRA shall be considered part of the SOFTWARE and/or FIRMWARE and subject to the terms of this PSFLA (unless this PSFLA is superseded by a further PSFLA accompanying such replacement or modified version of or upgrade to the SOFTWARE and/or FIRMWARE). In the event that ZEBRA offers a replacement or modified version of or any upgrade to the SOFTWARE and/or FIRMWARE, (a) your continued use of the SOFTWARE and/or FIRMWARE is conditioned on your acceptance of such replacement or modified version of or upgrade to the SOFTWARE and/or FIRMWARE and any accompanying superseding PSFLA and (b) in the case of the replacement or modified SOFTWARE and/or FIRMWARE, your use of all prior versions of the SOFTWARE and/or FIRMWARE is terminated.
4. TERMINATION. Without prejudice to any other rights, ZEBRA may terminate this PSFLA if you fail to comply with the terms and conditions of this PSFLA. ZEBRA may terminate this PSFLA by offering you a superseding PSFLA for the SOFTWARE and/or FIRMWARE or any replacement or modified version of or upgrade to the SOFTWARE and/or FIRMWARE and conditioning your continued use of the SOFTWARE and/or FIRMWARE or such replacement, modified or upgraded version on your acceptance of such superseding PSFLA. In addition, ZEBRA may terminate this PSFLA by notifying you that your continued use of the SOFTWARE and/or FIRMWARE is prohibited. In the event that ZEBRA terminates this PSFLA, you must immediately stop using the SOFTWARE and/or FIRMWARE and destroy all copies of the SOFTWARE and/or FIRMWARE and all of its component parts.
 5. COPYRIGHT. All title and copyrights in and to the SOFTWARE and FIRMWARE, the accompanying printed materials, and any copies of the SOFTWARE and FIRMWARE, are owned by ZEBRA or its suppliers. All title and intellectual property rights in and to the content which may be accessed through use of the SOFTWARE and/or FIRMWARE is the property of the respective content owner and may be protected by applicable copyright or other intellectual property laws and treaties. This PSFLA grants you no rights to use such content. If this SOFTWARE and/or FIRMWARE contains documentation which is provided only in electronic form, you may print one copy of such electronic documentation. You may not copy the printed materials accompanying the SOFTWARE and/or FIRMWARE.
 6. U.S. GOVERNMENT RESTRICTED RIGHTS. All SOFTWARE and/or FIRMWARE provided to the U.S. Government pursuant to solicitations issued on or after December 1, 1995 is provided with the commercial rights and restrictions described elsewhere herein. All SOFTWARE and/or FIRMWARE provided to the U.S. Government pursuant to solicitations issued prior to December 1, 1995 is provided with RESTRICTED RIGHTS as provided for in FAR, 48 CFR 52.227-14 (JUNE 1987) or DFAR, 48 CFR 252.227-7013 (OCT 1988), as applicable.

7. EXPORT RESTRICTIONS. You agree that you will not export or re-export the SOFTWARE and/or FIRMWARE, any part thereof, or any process or service that is the direct product of the SOFTWARE and/or FIRMWARE (the foregoing collectively referred to as the "RESTRICTED COMPONENTS"), to any country, person or entity subject to U.S. export restrictions. You specifically agree not to export or re-export any of the RESTRICTED COMPONENTS (i) to any country to which the U.S. has embargoed or restricted the export of goods or services, which currently include, but are not necessarily limited to Cuba, Iran, Iraq, Libya, North Korea, Sudan and Syria, or to any national of any such country, wherever located, who intends to transmit or transport the RESTRICTED COMPONENTS back to such country; (ii) to any person or entity who you know or have reason to know will utilize the RESTRICTED COMPONENTS in the design, development or production of nuclear, chemical or biological weapons; or (iii) to any person or entity who has been prohibited from participating in U.S. export transactions by any federal agency of the U.S. government. You warrant and represent that neither the U.S. Commerce Department, Bureau of Export Administration nor any other U.S. federal agency has suspended, revoked or denied your export privileges.
8. DISCLAIMER OF WARRANTIES. ZEBRA AND ITS SUPPLIERS PROVIDE THE SOFTWARE AND/OR FIRMWARE "AS IS" AND WITH ALL FAULTS, AND HEREBY DISCLAIM ALL OTHER WARRANTIES AND CONDITIONS, EITHER EXPRESS, IMPLIED OR STATUTORY, INCLUDING BUT NOT LIMITED TO ANY (IF ANY) IMPLIED WARRANTIES OR CONDITIONS OF MERCHANTABILITY, OF FITNESS FOR A PARTICULAR PURPOSE, OF LACK OF VIRUSES, AND OF LACK OF NEGLIGENCE OR LACK OF WORKMANLIKE EFFORT. ALSO, THERE IS NO WARRANTY OR CONDITION OF TITLE, OF QUIET ENJOYMENT, OR OF NONINFRINGEMENT. THE ENTIRE RISK ARISING OUT OF THE USE OR PERFORMANCE OF THE SOFTWARE AND FIRMWARE IS WITH YOU. ZEBRA DOES NOT WARRANT THAT THE OPERATION OF THE SOFTWARE OR FIRMWARE WILL BE UNINTERRUPTED OR ERROR FREE.
9. EXCLUSION OF ALL DAMAGES. TO THE MAXIMUM EXTENT PERMITTED BY APPLICABLE LAW, IN NO EVENT SHALL ZEBRA OR ITS SUPPLIERS BE LIABLE FOR ANY CONSEQUENTIAL, INCIDENTAL, DIRECT, INDIRECT, SPECIAL, PUNITIVE, OR OTHER DAMAGES WHATSOEVER (INCLUDING, WITHOUT LIMITATION, DAMAGES FOR ANY INJURY TO PERSON OR PROPERTY, DAMAGES FOR LOSS OF PROFITS, BUSINESS INTERRUPTION, LOSS OF BUSINESS INFORMATION, FOR LOSS OF PRIVACY FOR FAILURE TO MEET ANY DUTY INCLUDING OF GOOD FAITH OR OF REASONABLE CARE, FOR NEGLIGENCE, AND FOR ANY PECUNIARY OR OTHER LOSS WHATSOEVER) ARISING OUT OF OR IN ANY WAY RELATED TO THE USE OF OR INABILITY TO USE THE SOFTWARE OR FIRMWARE, WHETHER BASED ON CONTRACT, TORT, NEGLIGENCE, STRICT LIABILITY OR OTHERWISE, EVEN IF ZEBRA OR ANY SUPPLIER HAS BEEN ADVISED OF THE POSSIBILITY OF SUCH DAMAGES. THIS EXCLUSION OF DAMAGES SHALL BE EFFECTIVE EVEN IF ANY REMEDY FAILS OF ITS ESSENTIAL PURPOSE.
10. LIMITATIONS AND RELEASE OF LIABILITY.
 - To the extent that the SOFTWARE and/or FIRMWARE covered by this PSFLA includes emulation libraries, emulation libraries are offered "as is". ZEBRA does not provide any warranty associated with the emulation libraries.
 - The emulation library does not work 100% correctly or cover 100% of the functionality of the printer language being emulated. Modifications may be required for each target application. If such modification is necessary, prior to making any such modification, you are required to contact ZEBRA to obtain express written consent to make such modification.

